



Council Chambers,
BERRIGAN NSW 2712

Sir/Madam,

The Ordinary Meeting of the Council of the Shire of Berrigan will be held in the **Council Chambers**, Berrigan, on **21st June, 2017** when the following business will be submitted:-

9:00AM

Public Question Time

COUNCIL MEETING

1.	APOLOGIES	2
2.	DECLARATION OF ITEMS OF PECUNIARY OR OTHER INTEREST	2
3.	VISITORS ATTENDING MEETING.....	2
4.	CONFIRMATION OF MINUTES	2
5.1	FINANCE – ACCOUNTS	2
5.2	DISABILITY INCLUSION ACTION PLAN.....	7
5.3	INTEGRATED PLANS	8
5.4	FIRE AND EMERGENCY SERVICES LEVY	11
5.5	CODE OF CONDUCT – APPOINTMENT OF PANEL OF CONDUCT REVIEWERS.....	12
5.6	RATES AND CHARGES 2017/18.....	14
5.7	REGISTER OF DELEGATIONS	22
5.8	REFERENCES POLICY.....	33
5.9	REIMBURSEMENT OF RELOCATION EXPENSES POLICY	36
5.10	EARLY RELEASE OF SUBDIVISION CERTIFICATES POLICY	39
5.11	PRE-EMPLOYMENT MEDICAL POLICY.....	44
5.12	REVENUE POLICY.....	48
5.13	REVOCATION OF COUNCIL POLICIES.....	67
5.14	TENDER T01/17/18 ANNUAL PLANT HIRE.....	69
5.15	TENDER T02/17/18 SUPPLY OF QUARRY PRODUCTS	71
5.16	TENDER T03/17/18 SUPPLY OF ELECTRICAL SERVICES	73
6.1	LIONS PARK, TOCUMWAL.....	75
6.2	FINANCIAL ASSISTANCE GRANT	76
6.3	DEVELOPMENT DETERMINATIONS FOR MONTH OF MAY 2017	77
7.	CLOSED COUNCIL	80
	RESOLUTIONS FROM THE CLOSED COUNCIL MEETING.....	83
8.1	MINUTES OF THE TECHNICAL SERVICES COMMITTEE MEETING	84
8.2	MINUTES OF THE RISK MANAGEMENT COMMITTEE MEETING	86
9.	MAYOR’S REPORT	99
10.	DELEGATES REPORT	100
11.	GENERAL BUSINESS	101
12.	CLOSE OF MEETING	

No business, other than that on the Agenda, may be dealt with at this meeting unless admitted by the Mayor.

ROWAN PERKINS
GENERAL MANAGER



Council Meeting

Wednesday 21st June, 2017

BUSINESS PAPER

1. APOLOGIES

Cr John Bruce

2. DECLARATION OF ITEMS OF PECUNIARY OR OTHER INTEREST

3. VISITORS ATTENDING MEETING

4. CONFIRMATION OF MINUTES

RECOMMENDATION – that the Minutes of the meeting held in the Council Chambers on Wednesday 17th May, 2017 and the Minutes of the extraordinary meeting held in the Council Chambers on Wednesday 7th June, 2017 be confirmed.

5.1 FINANCE – ACCOUNTS

AUTHOR: Finance Manager

STRATEGIC OUTCOME: Good government

STRATEGIC OBJECTIVE: 2.2 Ensure effective governance by Council of Council operations and reporting

RECOMMENDATION – that the Financial Statement, Bank Reconciliation Certificate and Petty Cash Book made up to 31 May 2017, be received and that the accounts paid as per Warrant No. 05/17 totaling \$4,480,440.59 be confirmed.

Items requiring Council Resolution

REPORT

- a) A Financial Statement covering all funds of the Council indicating the Bank Balances as at 31 May 2017 is certified by the Finance Manager.
- b) The Finance Manager certifies that the Cash Book of the Council was reconciled with the Bank Statements as at 31 May 2017.
- c) The Finance Manager certifies the Accounts, including the Petty Cash Book made up to 31 May 2017, totaling \$4,480,440.59 and will be submitted for confirmation of payment as per Warrant No. 05/17
- d) The Finance Manager certifies that all Investments have been placed in accordance with:
- i. Council's Investment Policy,
 - ii. Section 625 of the Local Government Act 1993 (as amended),
 - iii. the Minister's Amended Investment Order gazetted 11 January 2011,
 - iv. clause 212 of the Local Government (General) Regulations 2005, and
 - v. Third Party Investment requirements of the Office of Local Government Circular 06-70.
- e) May has seen an increase in total funds compared to the end of April. This increase is a result of the receipt of the fourth instalment of rates and the Financial Assistance Grant.

The cash position is once again better (\$3.5 M) than the same period last year.

The general pattern in cash holdings over the year is still comparable however. Total funds held are expected to decrease in June as creditor payments are finalised for the 2016/2017 financial year.

**R
E
S
O
L
U
T
I
O
N**

Items requiring Council Resolution

Statement of Bank Balances as at 31 May 2017

Bank Account Reconciliation

Cash book balance as at 1 May 2017	\$ 3,027,228.22
Receipts for May 2017	\$ 3,810,672.36
Term Deposits Credited Back	\$ -
	\$ 6,837,900.58

Less Payments Statement No 05/17

Cheque Payments V075755 - V075766	\$ 59,877.35
Electronic Funds Transfer (EFT) payroll	\$ 763,952.05
Electronic Funds Transfer (EFT) Creditors E026332 - E026580	\$ 1,634,267.36
Term Deposits Invested	\$ 2,000,000.00
Loan repayments, bank charges, etc	\$ 22,343.83
Total Payments for May 2017	\$ 4,480,440.59
Cash Book Balance as at 31 May 2017	\$ 2,357,459.99

Bank Statements as at 31 May 2017

Plus Outstanding Deposits	\$ 2,378,288.58
Less Outstanding Cheques/Payments	\$ 20,828.59
Reconciliation Balance as at 31 May 2017	\$ 2,357,459.99

INVESTMENT REGISTER

INSTITUTION	DEPOSIT NO.	TERM (days)	RATE	MATURITY DATE	INSTITUTION TOTAL
AMP	125/16	181	2.75%	4/09/2017	\$ 2,000,000.00
AMP	117/15	273	2.75%	22/12/2017	\$ 2,000,000.00
Goulburn Murray Credit Union	131/17	180	2.75%	20/11/2017	\$ 2,000,000.00
Goulburn Murray Credit Union	124/16	275	2.75%	13/01/2018	\$ 2,000,000.00
Bendigo Bank	128/16	270	2.85%	17/09/2017	\$ 2,000,000.00
Bendigo Bank	122/16	184	2.65%	30/11/2017	\$ 2,000,000.00
Central Murray Credit Union	104/14	122	2.80%	16/07/2017	\$ 2,000,000.00
Central Murray Credit Union	126/16	365	3.05%	30/08/2017	\$ 2,000,000.00
Central Murray Credit Union	130/17	365	3.05%	1/03/2018	\$ 1,000,000.00
Defence Bank Limited	102/14	183	2.60%	4/10/2017	\$ 2,000,000.00
Defence Bank Limited	106/14	270	2.70%	24/12/2017	\$ 1,000,000.00
Defence Bank Limited	129/17	365	2.80%	28/02/2018	\$ 1,000,000.00
ME Bank	127/16	182	2.65%	28/11/2017	\$ 2,000,000.00
T-CORP HOURGLASS AT CALL		AT CALL			\$ 2,500,000.00
					\$ 25,500,000.00

Total Funds Held at 31 May 2017

\$27,857,459.99

Carla von Brockhusen - Finance Manager

Items requiring Council Resolution

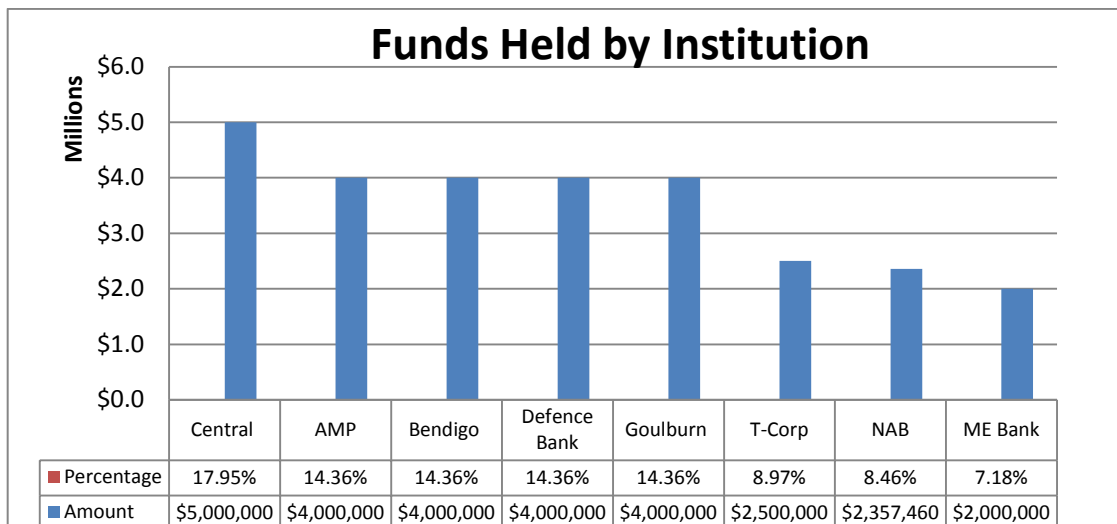
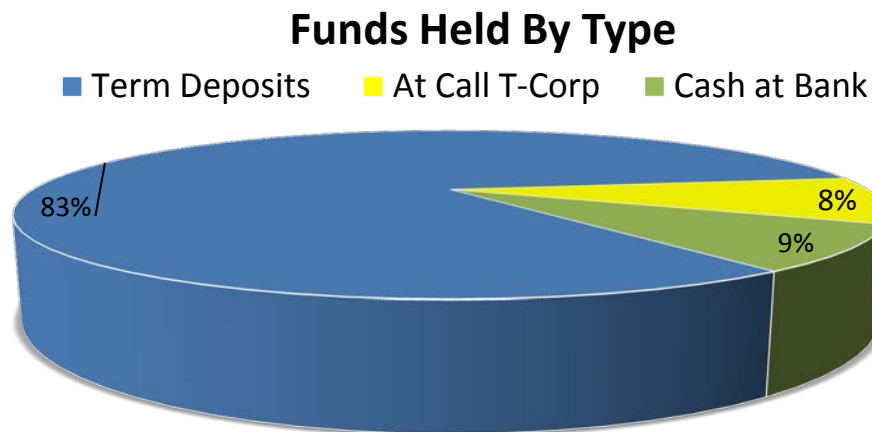
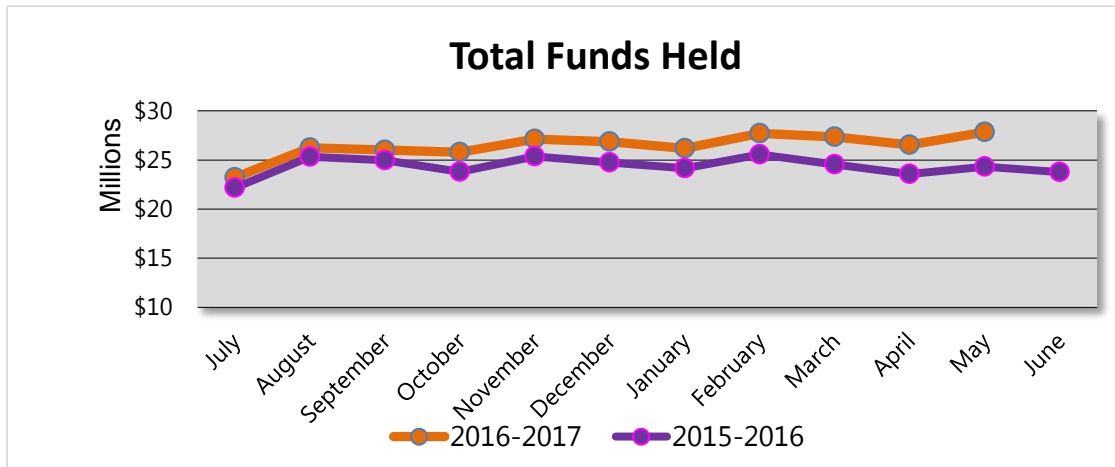

RESOLUTION

Items requiring Council Resolution

Prior Financial Institution	Previous Investment			Current Financial Institution	New Investment		
	Term (Days)	Amount	Interest Rate		Term (Days)	Amount	Interest Rate
				GMCU	182	\$2M	2.75%
ME BANK	180	\$2M	2.75%	ME BANK	182	\$2M	2.65%
BENDIGO	365	\$2M	3.00%	BENDIGO	184	\$2M	2.65%

RESOLUTION

Items requiring Council Resolution

5.2 DISABILITY INCLUSION ACTION PLAN**AUTHOR:** Strategic & Social Planning Coordinator**STRATEGIC OUTCOME:** Supported and engaged communities**STRATEGIC OBJECTIVE:** 3.1 Create safe, friendly and accessible communities**FILE NO:****RECOMMENDATION:** - that the Council

1. Adopt the Berrigan Shire Council Active Ageing and Disability Inclusion Strategy and Action Plan 2017 – 2021 ([Appendix “A”](#)).
2. Endorse an Accessible Version of this Plan ([Appendix “B”](#)).
3. Provide copies of the adopted Disability Inclusion Strategy and Action Plan to the Disability Council NSW and the Minister for Disability Services NSW.

REPORT:

Under the Disability Inclusion Regulation 2014, councils must prepare a disability inclusion plan by 1 July 2017.

[Appendix “A”](#) was adopted by the Council as its Draft Disability Inclusion Plan at its Ordinary Council meeting 21st April 2017 and placed on public exhibition 22 April 2017. Focus Group participants, local Disability Support and Advocacy Services, Aged Care Services and the Murrumbidgee Local Health District have also received copies of the Draft Plan and been invited to provide comment.

Centacare SW NSW provided comment noting that the omission of the psychosocial support service Hume Partners in Recovery. The appended Plan now includes Hume Partners in Recovery Program.

For Council endorsement also, is an accessible version of the Active Ageing and Disability Inclusion Strategy and Action Plan 2017 – 2021 – [appendix “B”](#). This accessible version of the Plan is a plain English version of the Plan that can be read out loud using document reader technology.

Items requiring Council Resolution

5.3 INTEGRATED PLANS

AUTHOR: Strategic & Social Planning Coordinator

STRATEGIC OUTCOME: Good government

STRATEGIC OBJECTIVE: 2.2 Ensure effective governance by Council of Council operations and reporting

FILE NO:

RECOMMENDATION: - that the Council, having given consideration to submissions received up until 5:00pm on the 15th June 2017:

1. adopt on behalf of the community, the Berrigan Shire 2027 Community Strategic Plan developed by the Council pursuant to s402(1) – (7) of the Local Government Act 1993 ([Appendix “C”](#)).
2. adopt the Berrigan Council Resourcing Strategy 2017 – 2027 inclusive of Council’s:
 - Long Term Financial Strategy and Plan 2017 – 2027 ([Appendix “D”](#));
 - Asset Management Strategy and Plan 2017 – 2027 ([Appendix “E”](#)) and
 - Workforce Management and Development Strategy and Plan 2017 – 2021 ([Appendix “F”](#)).
3. adopt the Berrigan Shire Council Delivery Program 2017 – 2021 ([Appendix “G”](#)).
4. adopt the Berrigan Shire Council Annual Operational Plan 2017 – 2018 ([Appendix “H”](#)).

REPORT:

Per the provisions of the Local Government Act, 1993 (s403 – 404) Council’s suite of integrated plans was placed on public exhibition for 28 days from the 17th May 2017 – 15th June 2017. Public submissions and comment invited until the close of submissions and comment at 5:00pm on the 15th June 2017.

Copies of public comments and the submissions received are attached as [appendix “I”](#). Briefly, the submissions relate to:

- The installation of toilets at Shire Cemeteries.
- Works completed at the Tocumwal Recreation Reserve.

Items requiring Council Resolution

The first submission for consideration by the Council is that of the Lions Club of Berrigan. Included in this submission are letters of support from the following Berrigan community groups:

- Berrigan Branch Red Cross
- Berrigan Mens' Shed Inc.
- Sporties Berrigan
- Combined Pensioners and Superannuates Association of NSW (Berrigan Branch)
- Uniting Church Australia – Berrigan
- United Hospital Auxiliaries of NSW Inc (Berrigan)
- Berrigan and District Development Association

The Lions Club of Berrigan would like the Council to give consideration to the inclusion in Council's Annual Operational Plan 2017 – 2018 the 'installation of Toilet facilities at the Berrigan Cemetery, to match the one available to Finley & Barooga'.

Similarly, the Lions Club of Tocumwal, in a second and separate submission has also requested that the Council install toilet facilities at the Tocumwal Cemetery. The submission by the Lions Club of Tocumwal asked the Council to include this as an item on its agenda.

The Council in its adopted Draft Annual Operational Plan and Draft Budget 2017/18 included in the Draft Annual Operational Plan 2017/18 allocated \$12,000 to the installation and cleaning of toilets at the Barooga and Finley Cemeteries and amended accordingly its 4-year Draft Capital Works Program to absorb the \$25,000 cost per toilet. As part of its earlier discussions on this issue, the Council also approved an increase in cemetery user charges of \$6,000 per annum to meet half of the cost of cleaning the public toilets to be installed at Barooga and Finley cemeteries.

The options available to the Council include:

1. Establishing a rolling program of toilet installation over the life of the Delivery Program further the priority order for toilet installation could be determined by a review of the number of burials conducted at each cemetery 2015 – 2017 or some other time frame determined by the Council.
2. Allocating an additional \$50,000 to Council's Draft Capital Works Program for the 2017/18 financial year. This allocation of funds would be needed to finance the installation of toilets at the Tocumwal and Berrigan Cemeteries in addition to the Finley and Barooga Cemeteries. This option would also require an across the board increase of user charges to \$12,000 per annum at all cemeteries to meet half the ongoing cost of cleaning the new public toilets.

Items requiring Council Resolution

3. Include the request of the Tocumwal and Berrigan Lions' Clubs in the Council's future program of proposed capital works and have Council Officers develop the business case and discuss at the Council's annual Corporate Workshop.

The other submission received is from the Council's Section 355 Tocumwal Recreation Reserve Committee. Council Officers' 2016/17 provided advice to the Committee of the Council's support for the upgrade of the toilets at the Tocumwal Recreation Reserve. Attached for consideration by the Council is a request from the Tocumwal Recreation Reserve Committee for the reimbursement of \$14,380 spent by the Committee for the upgrade of the Tocumwal Recreation Reserve toilets.

The delay experienced in the receipt and the timing of this payment is problematic. The Council's 2016/17 Recreation Reserve budget is now fully committed. Council Officers have inspected the works and are satisfied with the quality of the work undertaken and the cost of the upgrade.

Options for consideration by the Council include:

1. Allocating funds in the 2017/18 budget and reimbursing the Committee for the works completed in the new financial year.
2. Negotiating with the Committee the amount to be paid by the Council due to the delay experienced in the receipt of this request.

The advice and the direction of the Council is sought on these options.

Items requiring Council Resolution

5.4 FIRE AND EMERGENCY SERVICES LEVY**AUTHOR:** Revenue Officer**STRATEGIC OUTCOME:** Good government**STRATEGIC OBJECTIVE:** 2.2 Ensure effective governance by Council of Council operations and reporting**FILE NO:** 25.138.4**RECOMMENDATION:** - that the Council note the deferral of the implementation of the Fire and Emergency Services Levy by the NSW Government.

REPORT:

Councillors may be aware that Berrigan Shire Council has been working as one of the lead Councils in NSW with the implementation the new Fire and Emergency Services Levy (FESL).

FESL is a levy paid alongside council rates that will fund the work Fire and Rescue NSW, the NSW Rural Fire Service and the NSW State Emergency Service do to protect the community from fire, flood, storms and other natural disasters. It is to be collected by Councils via their rate notices.

Council staff have been working with the Office of State Revenue (OSR), Office of Local Government (OLG), NSW Valuer General's Officer and NSW Treasury as well as with the Council's software provider Civica and the Council's printing contractor SEMA on the implementation of FESL – expected to be in place from 1 July 2017.

FESL has now been deferred by the NSW Premier and will not be going on the 2017/18 rates notices. Given the time and effort put into this project by my team, it is somewhat disappointing to have this decision made at such a late date. However, the work completed should be able to be used if and when FESL is implemented at a later date.

The NSW government has committed to reimbursing Councils their "reasonable costs" incurred to date in the implementation of FESL.

[Appendix "J"](#) attached is correspondence from NSW Treasury outlining the deferment of the project.

 Items requiring Council Resolution

5.5 CODE OF CONDUCT – APPOINTMENT OF PANEL OF CONDUCT REVIEWERS

AUTHOR: Director Corporate Services

STRATEGIC OUTCOME: Good government

STRATEGIC OBJECTIVE: 2.2 Ensure effective governance by Council of Council operations and reporting

FILE NO: 13.045.3

RECOMMENDATION: - that the Council appoint the following persons to the Berrigan Shire Council Panel of Conduct Reviewers for a four year term commencing 1 July 2017:-

1. The Centium Group – Sydney
2. Harris Wheeler Lawyers – Newcastle
3. Sinc Solutions Strategic Independent Consulting – Glebe
4. Mediate Today Pty Ltd – Shellharbour,
5. Charlton Consulting Pty Ltd – Wodonga
6. Tress Cox Lawyers – Sydney
7. Prevention Partners – North Parramatta
8. O’Connell Workplace Solutions – Sydney
9. Workplace Investigation Services – Newport (NSW)
10. BAL Lawyers – Canberra

REPORT:

As the Council may be aware, it is required under The Procedures for the Administration of the Model Code of Conduct for local councils in NSW to appoint a panel of Conduct Reviewers that it may use under its adopted Code of Conduct.

To assist with this process, RAMROC recently called for expressions of interests from suitably qualified applicants to form part of a panel of reviewers that Councils could appoint as their individual Panels.

Following receipt of applications and vetting by RAMROC a list of 10 Conduct Reviewers was appointed by RAMROC from which Councils could select their own Panels.

The Panel was intended to provide a range of skills from which Councils could select one or more individuals to assess complaints made under its Code of Conduct.

Items requiring Council Resolution

Given the above it is suggested that the Council could also appoint the RAMROC selected individuals as its Panel of Conduct Reviewers.

A copy of the recommended Panel members' original application to RAMROC is available from the General Manager for perusal by interested Councillors.

RESOLUTION

Items requiring Council Resolution

5.6 RATES AND CHARGES 2017/18

AUTHOR: Revenue Officer

STRATEGIC OUTCOME: Good government

STRATEGIC OBJECTIVE: 2.2 Ensure effective governance by Council of Council operations and reporting

FILE NO: 25.138.1

RECOMMENDATION: - See below.

REPORT:

The various rates and fees & charges are based upon the Council's Integrated Plans that are considered elsewhere in the agenda and also Council's Rating and Revenue Policy.

RATES AND CHARGES

The following rates and charges resolutions will, if adopted, implement the Council's intended rating model to achieve an overall permissible increase to Ordinary Rates income of **1.5%** (as per the Independent Pricing and Regulatory Tribunal [IPART] rate peg). The increase in annual charges has been set at **2.5%** increase. The onsite sewer maintenance charge has increased by **57%**

MAKING OF RATES AND CHARGES FOR 2017/2018

The making of rates and charges must be made by resolution of Council, pursuant to Sections 534 and 535 of the *Local Government Act 1993*, as set out below.

GENERAL FUND – Ordinary Rates

In accordance with *Section 535 of the Local Government Act, 1993*, (herein referred to as "the Act"), that pursuant to Section 494 of the Act, **Ordinary Rates** for the following rating categories, **for the period 1st July 2017 to the 30th June 2018**, shall now be made by resolution;

Items requiring Council Resolution

IT IS HEREBY RESOLVED – that Council make and levy an Ordinary Rate of **0.59126 cents** per dollar of land value on all rateable land within the Berrigan Shire Council local government area sub-categorised as:

- **FARMLAND - BAROOGA**
- **FARMLAND - BERRIGAN**
- **FARMLAND - FINLEY**
- **FARMLAND - TOCUMWAL**
- **FARMLAND – GRAVEL PITS**

IT IS HEREBY RESOLVED – that Council make and levy an Ordinary Rate of **0.83995 cents** per dollar of land value on all rateable land within the Berrigan Shire Council local government area categorised as **RESIDENTIAL**.

IT IS HEREBY RESOLVED – that Council make and levy an Ordinary Rate of **0.83995 cents** per dollar of land value on all rateable land within the Berrigan Shire Council local government area sub-categorised as:

- **RESIDENTIAL RIVER LAND – BAROOGA**
- **RESIDENTIAL RIVER LAND – TOCUMWAL**

IT IS HEREBY RESOLVED – that Council make and levy an Ordinary Rate of **0.6284 cents** per dollar of land value on all rateable land within the Berrigan Shire Council local government area sub-categorised as:

- **RESIDENTIAL RURAL – BAROOGA**
- **RESIDENTIAL RURAL – BERRIGAN**
- **RESIDENTIAL RURAL – FINLEY**
- **RESIDENTIAL RURAL – TOCUMWAL**

IT IS HEREBY RESOLVED – that Council make and levy an Ordinary Rate of **1.0539 cents** per dollar of land value on all rateable land within the Berrigan Shire Council local government area sub-categorised as **RESIDENTIAL – BAROOGA**.

IT IS HEREBY RESOLVED – that Council make and levy an Ordinary Rate of **3.4155 cents** per dollar of land value on all rateable land within the Berrigan Shire Council local government area sub-categorised as **RESIDENTIAL – BERRIGAN**.

IT IS HEREBY RESOLVED – that Council make and levy an Ordinary Rate of **2.6709 cents** per dollar of land value on all rateable land within the Berrigan Shire Council local government area sub-categorised as **RESIDENTIAL – FINLEY**.

IT IS HEREBY RESOLVED – that Council make and levy an Ordinary Rate of **1.1202 cents** per dollar of land value on all rateable land within the Berrigan Shire Council local government area sub-categorised as **RESIDENTIAL – TOCUMWAL**.

**R
E
S
O
L
U
T
I
O
N**

Items requiring Council Resolution

IT IS HEREBY RESOLVED – that Council make and levy an Ordinary Rate of **1.0539 cents** per dollar of land value on all rateable land within the Berrigan Shire Council local government area sub-categorised as

- **BUSINESS HOSPITALITY- BAROOGA**
- **BUSINESS INDUSTRIAL – BAROOGA**
- **BUSINESS ORDINARY – BAROOGA**
- **BUSINESS RURAL – BAROOGA**

IT IS HEREBY RESOLVED – that Council make and levy an Ordinary Rate of **3.4155 cents** per dollar of land value on all rateable land within the Berrigan Shire Council local government area sub-categorised as

- **BUSINESS HOSPITALITY- BERRIGAN**
- **BUSINESS INDUSTRIAL – BERRIGAN**
- **BUSINESS ORDINARY – BERRIGAN**
- **BUSINESS RURAL – BERRIGAN**

IT IS HEREBY RESOLVED – that Council make and levy an Ordinary Rate of **2.6709 cents** per dollar of land value on all rateable land within the Berrigan Shire Council local government area sub-categorised as

- **BUSINESS HOSPITALITY- FINLEY**
- **BUSINESS INDUSTRIAL – FINLEY**
- **BUSINESS ORDINARY – FINLEY**
- **BUSINESS RURAL – FINLEY**

IT IS HEREBY RESOLVED – that Council make and levy an Ordinary Rate of **1.1202 cents** per dollar of land value on all rateable land within the Berrigan Shire Council local government area sub-categorised as

- **BUSINESS HOSPITALITY- TOCUMWAL**
- **BUSINESS INDUSTRIAL – TOCUMWAL**
- **BUSINESS ORDINARY – TOCUMWAL**
- **BUSINESS RURAL – TOCUMWAL**

IT IS HEREBY RESOLVED – that Council make and levy an Ordinary Rate on all rateable land, as detailed below;

- rateable land sub-categorised as **MINING BAROOGA** on which an Ordinary Rate of **1.0539 cents** per dollar of land value be made and levied; and,
- rateable land sub-categorised as **MINING BERRIGAN** on which an Ordinary Rate of **3.4155 cents** per dollar of land value be made and levied; and,
- rateable land sub-categorised as **MINING FINLEY** on which an Ordinary Rate of **2.6709 cents** per dollar of land value be made and levied; and,

Items requiring Council Resolution

- rateable land sub-categorised as **MINING TOCUMWAL** on which an Ordinary Rate of **1.1202 cents** per dollar of land value be made and levied.

WATER FUND

-Annual Charges

In accordance with *Section 535 of the Local Government Act, 1993* (herein referred to as “the Act”), that Annual Water Supply charges, pursuant to the provisions of Sections 501 of the Act, **for the period 1st July 2017 to 30th June 2018**, shall now be made by resolution;

IT IS HEREBY RESOLVED – pursuant to the provisions of Section 501 of the Act that Council make and levy **Water Access Charges** on all properties in accordance with the **Rating and Revenue Policy 2017/18** (other than the land herein specified in the First Schedule under the conditions given), which is:-

- a) land that is supplied with water from a water pipe of the Council; or
- b) land that is situated within 225 metres of a water pipe of the Council, whether the land has frontage or not to the public road (if any) in which the water pipe is laid, even though the land is not actually supplied with water from any water pipe of the Council,

pursuant to,

water being able to be supplied to some part of the land from a standpipe at least 1 metre in height from the ground level, if such a pipe were laid and connected to the Council’s main;

under the following criteria:-

-for rateable properties

A compulsory annual fixed charge of **\$523.00** be made and levied for availability to the water supply system (known as the **Water Access Charge**) and levied for each supply to the property, or multiples of each charge if the property is deemed to have multiple supplies/connections.

-for non-rateable properties

A compulsory annual fixed charge of **\$523.00** be made and levied for the recovery costs for providing access to the water supply system (known as the **Water Access Charge**) or multiples of each charge if the property is deemed to have multiple supplies/connections.

R
E
S
O
L
U
T
I
O
N

Items requiring Council Resolution

-Water Supply Special Rate or Charge

In accordance with Section 535 of the Act that a Water Supply Charge pursuant to the provisions of Section 551 of the Act, for the period defined by the relevant meter reading periods/cycles, shall now be made by resolution;

WATER CONSUMPTION CHARGES – All Town supplies

In accordance with *Section 535 of the Local Government Act, 1993* (herein referred to as “the Act”) that a **Water Consumption Charge**, pursuant to the provisions of Section 502 of the Act, for the period defined by the relevant meter reading periods/cycles, shall now be made by resolution;

IT IS HEREBY RESOLVED – that pursuant to Section 502, 539 and 540 of the Act that Council make and levy **Water Consumption Charges**.

Unfiltered (Barooga, Berrigan & Finley) **\$0.73 per kl** (stage 4 restrictions in force) **\$0.52 per kl** (other restrictions in force) **\$0.47 per kl** (no restrictions)

Treated (Barooga, Berrigan & Finley) **\$1.46 per kl** (stage 4 restrictions in force) **\$1.04 per kl** (other restrictions in force) **\$0.94 per kl** (no restrictions)

Treated (Tocumwal) **\$0.97 per kl** (stage 4 restrictions in force) **\$0.69 per kl** (other restrictions in force) **\$0.62 per kl** (no restrictions) in accordance with **Council’s 2017/18 Rates and Revenue Policies and 2017/18 Fees and Charges**.

SEWER FUND

-Annual Charges

In accordance with Section 535 of the *Local Government Act, 1993* (herein referred to as “the Act”), that an Annual Charge pursuant to the provisions of Section 501 of the Act, known as the **Sewerage Supply Charge**, for the **1st July 2017 to the 30th June 2018**, shall now be made by resolution;

IT IS HEREBY RESOLVED – that pursuant to the provisions of Section 501 of the Act, that Council make and levy **Sewerage Supply Charges**, for the availability of the service, on each rateable assessment on land within the designated sewerage supply areas, (other than the land herein specified in the First Schedule under the conditions given), as detailed below:

Sewerage Supply area	Charge
Barooga	\$526.00
Berrigan	\$526.00
Finley	\$526.00
Tocumwal	\$526.00

Items requiring Council Resolution

-Sewerage Pedestal Charge

In accordance with Section 535 of the Act, that a Sewer Charge, pursuant to the provisions of Section 501, 502 and 552, known as the **Sewerage Pedestal Charge, for the period 1st July 2017 to 30th June 2018**, shall now be made by resolution;

IT IS HEREBY RESOLVED – that Council make and levy a **Sewerage Pedestal Charge** as detailed below:

- in Barooga, Berrigan, Finley and Tocumwal rating areas,
 - for all non-rateable properties a charge of \$112.00 per cistern/toilet;
 - for all rateable properties, for each additional cistern/toilet in excess of two (2), a charge of \$112.00.

-Sewer Maintenance Charge

In accordance with Section 535 of the Act that a Sewer Charge, pursuant to the provisions of Section 501 and 552 of the Act, known as the **On-Site Sewer Maintenance Charge, for the 1st July, 2017 to the 30th June 2018**, shall now be made by resolution;

IT IS HEREBY RESOLVED – that Council make and levy a charge on each rateable assessment meeting criteria as stipulated in Council's Rating and Revenue Policy, as detailed below:

Name of Charge	Charge
On-Site Sewer Maintenance Charge	\$150.00

DOMESTIC WASTE MANAGEMENT SERVICES CHARGE

In accordance with Section 535 of the *Local Government Act, 1993* (herein referred to as "the Act"), that a **Domestic Waste Management Services Charge** pursuant to the provisions of Sections 496, 501, 502 and 504 of the Act, shall now be made by resolution;

IT IS HEREBY RESOLVED – that the charge, for the period **1st July 2017 to 30th June 2018**, to be made and levied upon each parcel of rateable land for which the service is available, being for the **availability** of regular removal of domestic waste, as follows:

1. **Domestic Waste Collected - \$279.00 made for the availability of one bin of the size and pattern and service approved by the Council;**

Items requiring Council Resolution

2. **Domestic Waste Collected – Additional - \$187.00** made for an additional bin of the size and pattern and service approved by the Council;
3. **Domestic Waste Uncollected - \$55.00** made on residential vacant land.

WASTE MANAGEMENT GARBAGE CHARGE

In accordance with Section 535 of the *Local Government Act, 1993* (herein referred to as “the Act”), that **Garbage charges**, pursuant to the provisions of Sections 501 and 502 of the Act, shall now be made by resolution;

IT IS HEREBY RESOLVED – that the charge, for the period **1st July 2017 to 30th June 2018**, to be made upon each parcel of rateable land within the garbage collection area for which the service is available for the regular removal of waste as approved by Council, as follows:

1. **Garbage Charge - \$261.00** made for the availability of one bin of the size and pattern approved by the Council;
2. **Garbage and Recycling Collected Charge - \$384.00** made for the availability of bins of the size and pattern and service approved by the Council;
3. **Recycling Collected Charge - \$124.00** made for the availability of an additional bin of the size and pattern and service approved by the Council.

STORMWATER MANAGEMENT SERVICE CHARGE – *Sections 496A and 501 of the Local Government Act, 1993*

In accordance with Section 535 of the *Local Government Act, 1993* (herein referred to as “the Act”), that a **Stormwater Management Service Charge**, pursuant to the provisions of Section 496A of the Act, and clause 125A and clause 125AA of the Local Government (General) Regulation 2005, shall now be made by resolution;

IT IS HEREBY RESOLVED – that a **Stormwater Management Service Charge** of:

- **\$25.00** be made and levied, for the period **1st July 2017 to 30th June 2018**, on each parcel of urban property that is liable for the charge, whether the works or service is either provided or proposed to be provided; or
- **\$12.50** be made and levied for the period **1st July 2017 to 30th June 2018**, on each parcel of urban strata property that is liable for the charge, whether the works or service is either provided or proposed to be provided.

Items requiring Council Resolution

INTEREST ON OVERDUE RATES AND CHARGES – Section 566, Local Government Act, 1993

COUNCIL HEREBY RESOLVES - that in accordance with the provisions of Section 566 of the *Local Government Act 1993*, that the **interest rate** to apply on overdue rates and charges for the period **1st July, 2017 to 30th June 2018**, will be charged at **7.5%** per annum on a daily basis.

RESOLUTION

Items requiring Council Resolution

5.7 REGISTER OF DELEGATIONS

AUTHOR: General Manager

STRATEGIC OUTCOME: Good government

STRATEGIC OBJECTIVE: 2.2 Ensure effective governance by Council of Council operations and reporting

FILE NO:

RECOMMENDATION: - that the Council, pursuant to S377 of the Local Government Act, adopt the delegations to Committees of the Council, the Mayor and the General Manager and delegations by other bodies as contained within the Delegation Register as circulated as [appendix "K"](#) of this Agenda.

REPORT:

One of the principle activities a Council must complete within the first twelve months of its term is a review of its Delegations.

Part 1 BACKGROUND

A number of sections of the Local Government Act, 1993 impact on existing Council delegations. The relevant sections include:

- 1) The role of the governing body;
- 2) The role of the Mayor;
- 3) The role of a Councillor
- 4) Functions of the General Manager;
- 5) The power of the Council to delegate;
- 6) Delegation by the General Manager; and
- 7) Delegation of Regulatory functions.

In addition, Section 380 of the Local Government Act 1993 requires that a Council must review all of its delegation within the first 12 months of its term of office.

Given the above, a review has been sought from the Council's solicitor of its existing delegations. The intent of this review has been incorporated into this new and appended "delegation" document.

A copy of the Council's present Delegation Register is also appended for comparison as [appendix "L"](#).

Items requiring Council Resolution

The document has also been reviewed to ensure that it includes all known enduring delegations (i.e. those not related to specific one off events) and that all Committee delegations are included, reflect present circumstances and are appropriate.

The major thrust of the various sections covering delegations is that the Council may delegate to the General Manager or any other person or body (not including another employee) any of a wide range of functions, excluding the those functions set out in Section 377 of the Local Government Act details of which are set out in the preamble to the proposed Delegation Register).

It is in this regulatory context that the delegations as set out are proposed.

The Delegation Register essentially comprises a preamble, an introduction and four key sections of delegations being:

- Delegations to Committees of the Council;
- Delegations to the Mayor;
- Delegations to the General Manager; and
- Delegations by other bodies

Delegations to Committees

This section provides for delegations to various Council Committees either to manage an asset or to provide a particular service. Committees of the Council that do not have delegations are “advisory” Committees and can only report to the Council rather than act in their own right.

This section reflects historical delegations to enduring Committees.

Delegations to the Mayor

The purpose of these delegations is effectively allow the Mayor to act for the Council i.e. to be its body and face and to negotiate for and represent the Council at meeting, public events and with other levels of government or at forums etc.

Other than reflecting current circumstances, these delegations are historic.

Delegations to the General Manager

This area of delegation is effectively of three components in that it attempts to specifically set out comprehensive list of delegations, recognizes that it is impossible to accurately reflect every possible delegation and nominates specific Acts under which it is intended to delegate functions to the General Manager in a non-specific nature and recognizing that these Acts regularly change.

Items requiring Council Resolution

This section is formed on this basis because:

- it is impossible to accurately list every specific delegation;
- the delegation will require continual updating due to changes in legislation and directions of other authorities; and
- the overall intention is to provide the capacity to allow those things that need to be done to be done with unduly delaying them waiting for reference to a Council meeting.

Delegations by Others

This reflects delegations that are specifically made to the General Manager or the Council by other authorities and effectively forms a record of those.

It is of concern that some other NSW legislation allows direct delegation to the general manager without reference to the Council.

In terms of considering the proposed delegations the following information is relevant:

FORMS OF DELEGATIONS

- 1) Each delegation or sub-delegation by a council is required under the local Government Act to:
 - a. be authorised by a resolution of the Council (in the case of a delegation by the Council), or by the General Manager (in the case of a delegation or sub-delegation by the General Manager);
 - b. be in writing and signed by a person authorised by the Council for that purpose, or by the General Manager (as appropriate);
 - c. be to a:
 - i) specified person or body by name; or
 - ii) to a particular officer or the holder of a particular office by reference to the title of the office concerned;
 - d. identify the functions, powers, authorities or duties delegated;
 - e. be exercised only in accordance with any conditions to which the delegation is subject.
- 2) Each delegation of authority should, where appropriate:
 - a. specify the terms and conditions on which a delegation may be exercised, or the limitations on the exercise of delegated authority (if appropriate);

Items requiring Council Resolution

- b. specify the period of time in which the delegation may be exercised (if appropriate);
- c. specify reporting requirements in relation to the exercise of the delegated authority; and
- d. be made subject to limitations or conditions as to:
 - i) the extent of the authority so delegated (e.g. to authorise Development Approvals);
 - ii) how it may be exercise (e.g. in accordance with the provisions of specified codes or policies);
 - iii) in what circumstances it may be exercised (e.g. where no objections have been lodged, the Development Application is in accordance with Council policies, etc.).

DELEGATIONS OF AUTHORITY - RELEVANT LEGISLATION

The following reflect various relevant sections of the Local Government Act

1. The role of the governing body

S223 The role of the governing body is as follows:

- (a) to direct and control the affairs of the council in accordance with this Act,
- (b) to provide effective civic leadership to the local community,
- (c) to ensure as far as possible the financial sustainability of the council,
- (d) to ensure as far as possible that the council acts in accordance with the principles set out in Chapter 3 and the plans, programs, strategies and polices of the council,
- (e) to develop and endorse the community strategic plan, delivery program and other strategic plans, programs, strategies and policies of the council,
- (f) to determine and adopt a rating and revenue policy and operational plans that support the optimal allocation of the council's resources to implement the strategic plans (including the community strategic plan) of the council and for the benefit of the local area,
- (g) to keep under review the performance of the council, including service delivery,
- (h) to make decisions necessary for the proper exercise of the council's regulatory functions,
- (i) to determine the process for appointment of the general manager by the council and to monitor the general manager's performance,

Items requiring Council Resolution

- (j) to determine the senior staff positions within the organisation structure of the council,
- (k) to consult regularly with community organisations and other key stakeholders and keep them informed of the council's decisions and activities,
- (l) to be responsible for ensuring that the council acts honestly, efficiently and appropriately.

The governing body is to consult with the general manager in directing and controlling the affairs of the council.

2. The role of the Mayor

S226 The role of the mayor is as follows:

- (a) to be the leader of the council and a leader in the local community,
- (b) to advance community cohesion and promote civic awareness,
- (c) to be the principal member and spokesperson of the governing body, including representing the views of the council as to its local priorities,
- (d) to exercise, in cases of necessity, the policy-making functions of the governing body of the council between meetings of the council,
- (e) to preside at meetings of the council,
- (f) to ensure that meetings of the council are conducted efficiently, effectively and in accordance with this Act,
- (g) to ensure the timely development and adoption of the strategic plans, programs and policies of the council,
- (h) to promote the effective and consistent implementation of the strategic plans, programs and policies of the council,
- (i) to promote partnerships between the council and key stakeholders,
- (j) to advise, consult with and provide strategic direction to the general manager in relation to the implementation of the strategic plans and policies of the council,
- (k) in conjunction with the general manager, to ensure adequate opportunities and mechanisms for engagement between the council and the local community,
- (l) to carry out the civic and ceremonial functions of the mayoral office,
- (m) to represent the council on regional organisations and at inter-governmental forums at regional, State and Commonwealth level,
- (n) in consultation with the councillors, to lead performance appraisals of the general manager,
- (o) to exercise any other functions of the council that the council determines.

Items requiring Council Resolution

3. The role of a Councillor

S232 The role of a councillor

- (1) The role of a councillor is as follows:
 - (a) to be an active and contributing member of the governing body,
 - (b) to make considered and well informed decisions as a member of the governing body,
 - (c) to participate in the development of the integrated planning and reporting framework,
 - (d) to represent the collective interests of residents, ratepayers and the local community,
 - (e) to facilitate communication between the local community and the governing body,
 - (f) to uphold and represent accurately the policies and decisions of the governing body,
 - (g) to make all reasonable efforts to acquire and maintain the skills necessary to perform the role of a councillor.
- (2) A councillor is accountable to the local community for the performance of the council.

4. Functions of the General Manager

S335 The general manager of a council has the following functions:

- (a) to conduct the day-to-day management of the council in accordance with the strategic plans, programs, strategies and policies of the council,
- (b) to implement, without undue delay, lawful decisions of the council,
- (c) to advise the mayor and the governing body on the development and implementation of the strategic plans, programs, strategies and policies of the council,
- (d) to advise the mayor and the governing body on the appropriate form of community consultation on the strategic plans, programs, strategies and policies of the council and other matters related to the council,
- (e) to prepare, in consultation with the mayor and the governing body, the council's community strategic plan, community engagement strategy, resourcing strategy, delivery program, operational plan and annual report,
- (f) to ensure that the mayor and other councillors are given timely information and advice and the administrative and professional support necessary to effectively discharge their functions,
- (g) to exercise any of the functions of the council that are delegated by the council to the general manager,

Items requiring Council Resolution

- (h) to appoint staff in accordance with the organisation structure determined under this Chapter and the resources approved by the council,
- (i) to direct and dismiss staff,
- (j) to implement the council's workforce management strategy,
- (k) any other functions that are conferred or imposed on the general manager by or under this or any other Act.

5. How does a council exercise its functions?

S355 A function of a council may, subject to this Chapter, be exercised:

- (a) by the council by means of the councillors or employees, by its agents or contractors, by financial provision, by the provision of goods, equipment, services, amenities or facilities or by any other means, or
- (b) by a committee of the council, or
- (c) partly or jointly by the council and another person or persons, or
- (d) jointly by the council and another council or councils (including by means of a Voluntary Regional Organisation of Councils of which the councils concerned are members), or
- (e) by a delegate of the council (which may, for example, be a Voluntary Regional Organisation of Councils of which the council is a member).

6. The Power of the Council to delegate

S377 General power of the council to delegate

- (1) A council may, by resolution, delegate to the general manager or any other person or body (not including another employee of the council) any of the functions of the council under this or any other Act, other than the following:
 - (a) the appointment of a general manager,
 - (b) the making of a rate,
 - (c) a determination under section 549 as to the levying of a rate,
 - (d) the making of a charge,
 - (e) the fixing of a fee,
 - (f) the borrowing of money,
 - (g) the voting of money for expenditure on its works, services or operations,
 - (h) the compulsory acquisition, purchase, sale, exchange or surrender of any land or other property (but not including the sale of items of plant or equipment),
 - (i) the acceptance of tenders to provide services currently provided by members of staff of the council,

Items requiring Council Resolution

- (j) the adoption of an operational plan under section 405,
 - (k) the adoption of a financial statement included in an annual financial report,
 - (l) a decision to classify or reclassify public land under Division 1 of Part 2 of Chapter 6,
 - (m) the fixing of an amount or rate for the carrying out by the council of work on private land,
 - (n) the decision to carry out work on private land for an amount that is less than the amount or rate fixed by the council for the carrying out of any such work,
 - (o) the review of a determination made by the council, and not by a delegate of the council, of an application for approval or an application that may be reviewed under section 82A of the Environmental Planning and Assessment Act 1979,
 - (p) the power of the council to authorise the use of reasonable force for the purpose of gaining entry to premises under section 194,
 - (q) a decision under section 356 to contribute money or otherwise grant financial assistance to persons,
 - (r) a decision under section 234 to grant leave of absence to the holder of a civic office,
 - (s) the making of an application, or the giving of a notice, to the Governor or Minister,
 - (t) this power of delegation,
 - (u) any function under this or any other Act that is expressly required to be exercised by resolution of the council.
- (1A) Despite subsection (1), a council may delegate its functions relating to the granting of financial assistance if:
- (a) the financial assistance is part of a specified program, and
 - (b) the program is included in the council's draft operational plan for the year in which the financial assistance is proposed to be given, and
 - (c) the program's proposed budget for that year does not exceed 5 per cent of the council's proposed income from the ordinary rates levied for that year, and
 - (d) the program applies uniformly to all persons within the council's area or to a significant proportion of all the persons within the council's area.
- (2) A council may, by resolution, sub-delegate to the general manager or any other person or body (not including another employee of the council) any function delegated to the council by the Departmental Chief Executive except as provided by the instrument of delegation to the council.

Items requiring Council Resolution

7. Delegation by the General Manager

S378 Delegations by the general manager

- (1) The general manager may delegate any of the functions of the general manager, other than this power of delegation.
- (2) The general manager may sub-delegate a function delegated to the general manager by the council to any person or body (including another employee of the council).
- (3) Subsection (2) extends to a function sub-delegated to the general manager by the council under section 377 (2).

8. Delegation of Regulatory functions

S379 Delegation of regulatory functions

- (1) A regulatory function of a council under Chapter 7 must not be delegated or sub-delegated to a person or body other than:
 - (a) a committee of the council of which all the members are councillors or of which all the members are either councillors or employees of the council, or
 - (b) an employee of the council, or
 - (c) a county council.
- (2) A regulatory function of a county council under Chapter 7 must not be delegated or sub-delegated to a person or body other than:
 - (a) a committee of the county council of which all the members are members of the county council or of which all the members are either members of the county council or employees of the county council, or
 - (b) an employee of the county council, or
 - (c) a council.
- (3) However, if:
 - (a) a regulatory function is delegated to a county council, the function may be delegated to the general manager and by the general manager to an employee of the county council, or
 - (b) a regulatory function is delegated to a council, the function may be delegated to the general manager and by the general manager to an employee of the council.

9. Pursuant to Section 380 Council must review all its delegations during the first twelve months of each term of office (which is the purpose of this review)

10. Section 381 of the Local Government Act provides:

Exercise of functions conferred or imposed on council employees under other Acts.

Items requiring Council Resolution

1. If, under any other Act, a function is conferred or imposed on an employee of a council or on the mayor or a councillor of a council, otherwise than by delegation in accordance with this section, the function is taken to be conferred or imposed on the council.
 2. Such a function may be delegated by the council in accordance with this Part.
 3. A person must not, under any other Act, delegate a function to:
 - The general manager, except with the approval of the council
 - An employee of the council, except with the approval of the council and the general manager.
- 11. Meaning of Authorised Person:**
- (a) an employee of a council generally or specially authorised by the council in respect of or whose duty it is to deal with, or to act in regard to, any acts, matters or things in relation to which the expression is used, or
 - (b) a police officer.

Whilst there has been some changes to specific legislated provision referred to above they mainly relate to "Roles and Functions" etc rather than the nature and process of the delegated authorities.

One change that does however require discussion is included where the previous S377 (functions that cannot be delegated) provided in part:

the acceptance of tenders which are required under this Act to be invited by the council,

This provision has now been modified to:

the acceptance of tenders to provide services currently provided by members of staff of the council,

The intent of this is that the Council can delegate to the General Manager the authority to accept tenders except where such acceptance does not relate to services provided by Council staff.

While the intent of this provision could be clearer I believe it is intended to protect Council staff from the actions of a general manager in contracting out those services.

Where services are jointly provided the intent is unclear i.e. road construction where both staff and contractors provide these services.

Regardless of the ambiguity, above, the change and the intent of the change is worthy of discussion and consideration by the Council. Set below are some

Items requiring Council Resolution

of the recognized issues related to delegating the acceptance of tenders to a general manager:

Advantages

At times could eliminate the need for extraordinary meetings;

Replicates what occurs when the Council purchases through other recognized procurement bodies that tender for goods and services on a statewide basis ie plant and equipment;

Could reduce start times for projects.

Disadvantages

Removes a level of Council scrutiny and cost control.

The proposed delegation reflects the status quo and if the Council wished to take advantage of the changed legislation it would need to specifically include this in the register along with any additional controls.

Additional controls could include such things as:

- Reporting of accepted tenders to the Council, as occurs with contracts utilized under tenders by other recognized bodies;
- Must be within adopted budget(s).

If the Council did choose to pursue the changed level of delegation, it can of course review this at any time if it becomes dissatisfied by the actions of the General Manager.

Items requiring Council Resolution

5.8 REFERENCES POLICY**AUTHOR:** Director Corporate Services**STRATEGIC OUTCOME:** Good government**STRATEGIC OBJECTIVE:** 2.1 Berrigan Shire 2022 objective and strategies inform Council planning and community led projects**FILE NO:** 22.123.1**RECOMMENDATION:** - that the Council:

- revoke its Policy for References; and
- adopt the Policy for References set out below.

62. REFERENCES POLICY**File Reference No:** 22.123.1**Strategic Outcome:** Good government**Date of Adoption:** 21/06/2017**Date for Review:** 16/06/2021**Responsible Officer:** Director Corporate Services**1. POLICY STATEMENT**

It is important that the Council and Council officers provide clear and factual information when providing references or acting as referees for current and former employees of Berrigan Shire Council.

It is also important that the privacy of personal information regarding current and former employees is protected in line with legislation, the Privacy Code of Practice for Local Government and the Council's Privacy Management Plan.

2. PURPOSE

This policy provides guidance to Council officers when providing references for current and former Council employees.

3. SCOPE

This policy applies to all Councillors, Council staff and other Council officials.

Items requiring Council Resolution

4. OBJECTIVE

This policy is developed to assist the Council with Delivery Plan Action 2.1.3.7:

Coordinate the delivery and management of Shire records and communications

5. DEFINITIONS

For the purposes of this policy, a reference is a statement:

- a) by the Council, or a Council officer,
- b) to a potential employer of a person who is a current or former employee of the Council,
- c) that relates to the employment of that person at the Council.

A reference may be written or verbal.

6. POLICY IMPLEMENTATION

References from the Council

Written references

The Council may provide a written reference for a current or former employee, on the request of that employee.

Written references provided by the Council will be produced by authorised officers on Council letterhead stationery and signed by the General Manager.

At a minimum, the reference will indicate the employee's length of service and position(s) held in the organisation. Further information about the employee may be included in the reference with the express consent of the employee.

Verbal references

Where the Council is requested by a potential employer, it may verify that a current or former employee works or has worked for the Council, the duration of that work, and the position occupied during that time.

Council officers providing a verbal reference will not give an opinion as to the suitability of a current or former employee for a particular position with any potential employer without the express and specific consent of that employee.

Items requiring Council Resolution

Council officers should ensure verbal responses made as a referee on behalf of the Council are succinct, businesslike and relevant to the position in question.

References from an individual Council officer

Staff may request a reference from an individual Council officer.

These references will:

1. not be provided on Council letterhead stationery.
2. clearly indicate that content of the reference contains the Council Officer's personal opinions and comments and not that of the organisation.

7. RELATED POLICIES OR STRATEGIES

7.1 Legislation

- *Local Government Act 1993*
- *Privacy and Personal Information Protection Act 1998*
- *Defamation Act 2005*
- *Privacy Code of Practice for Local Government*

7.2 Council policies and guidelines

- *Code of Conduct*
- *Privacy Management Plan*

REPORT:

The Council's policy for References is due for review. The policy provides guidance for staff and Councillors when acting as referees for current and former employees of Berrigan Shire Council.

Note that the scope of this policy is limited to references for **employment** purposes only.

The only changes to the existing policy are cosmetic and procedural.

The Council may adopt, amend or reject this proposed policy as it chooses.

Items requiring Council Resolution

5.9 REIMBURSEMENT OF RELOCATION EXPENSES POLICY**AUTHOR:** Director Corporate Services**STRATEGIC OUTCOME:** Good government**STRATEGIC OBJECTIVE:** 2.1 Berrigan Shire 2022 objective and strategies inform Council planning and community led projects**FILE NO:** 22.123.1**RECOMMENDATION:** - that the Council:

- revoke its Policy for Reimbursement of Relocation Expenses; and
- adopt the Policy for Reimbursement of Relocation Expenses set out below.

60 REIMBURSEMENT OF RELOCATION EXPENSES POLICY**File Reference No:** 22.123.1**Strategic Outcome:** Good government**Date of Adoption:** 21/06/2017**Date for Review:** 16/06/2021**Responsible Officer:** Director Corporate Services**1. POLICY STATEMENT**

In order to attract suitably qualified and skilled staff, Berrigan Shire Council may consider offering reimbursement of relocation expenses as part of an offer of employment.

It is important that offers and payment of relocation expenses are transparent and equitable.

2. PURPOSE

The purpose of this Policy is to give managers, finance and human resources staff and prospective employees guidance on reimbursement of relocation expenses for employees required to relocate to take up employment with Berrigan Shire Council.

3. SCOPE

This policy applies to all Council employees

Items requiring Council Resolution

4. OBJECTIVE

This Policy has been developed to assist the Council with Delivery Plan Action 2.1.3.5

Manage human resource and workforce development activities through the implementation of the Berrigan Shire's Workforce Development Plan 2017 – 2021

5. DEFINITIONS

Eligible employee: An employee required to relocate their primary place of residence from a residence outside Berrigan Shire to a new residence in Berrigan Shire in order to take up a position with the Council.

Primary place of residence: The residence where the employee ordinarily resides. This definition excludes arrangements where an employee uses temporary accommodation in the Shire and commutes on a weekly basis from a primary residence elsewhere.

Relocation expenses: The reasonable cost of relocating to a new primary place of residence. This may include the cost of a removalist or, for a self-removal, the cost of truck hire and fuel.

6. POLICY IMPLEMENTATION

Berrigan Shire Council will reimburse 50% of the relocation expenses of eligible employees up to \$1,500 – i.e. 50% of \$3,000 in relocation expenses.

This payment will be made on the following terms:

- The Council and the employee will agree on the terms of reimbursement before the acceptance of an offer of employment with the Council. An agreement to reimburse relocation expenses under this policy will be explicitly included in the letter of appointment. Retrospective reimbursement of relocation expenses is not permitted.
- Reimbursement will be made after six months continuous employment with the Council and subject to successful completion of any probation period.
- Reimbursement is made on the basis of actual expenses paid and the employee is required to provide receipts to support her/his claim.
- Authorisation for any payment under this policy must be given by the General Manager or Director Corporate Services/Technical Services as applicable

Items requiring Council Resolution

- In the case of genuine hardship, reimbursement under this policy can be made at an earlier date with the explicit approval of the General Manager.

The Finance Manager should be made aware of any agreement to pay relocation expenses as soon as possible to allow for any budgetary considerations.

7. RELATED POLICIES OR STRATEGIES

7.1. Legislation

- *Local Government Act 1993*
- *Local Government (State) Award 2014*

7.2. Council policies and guidelines

- *Berrigan Shire Council Code of Conduct*
- *Workforce Development Plan 2017-2021*
- *Salary Policy*
- *Guidelines on Payment of Expenses and Provision of Facilities to Council employees*

REPORT:

The Council's policy for Reimbursement of Relocation Expenses is due for review.

The only changes to the existing policy are cosmetic and procedural, mainly updating references to the Council's new Workforce Development Plan – to be adopted at this meeting.

The Council may adopt, amend or reject this proposed policy as it chooses.

Items requiring Council Resolution

5.10 EARLY RELEASE OF SUBDIVISION CERTIFICATES POLICY**AUTHOR:** Director Corporate Services**STRATEGIC OUTCOME:** Sustainable natural and built landscapes**STRATEGIC OBJECTIVE:** 1.1 Support sustainable use of our natural resources and built landscapes**FILE NO:** 07.094.1**RECOMMENDATION:** - That the Council:

- revoke its Policy for Early Release of Subdivision Certificates; and
- adopt the Policy for Early Release of Subdivision Certificates set out below.

58 EARLY RELEASE OF SUBDIVISION CERTIFICATES**File Reference No:** 07.094.3**Strategic Outcome:** Sustainable natural and built landscapes**Date of Adoption:** 21/06/2017**Date for Review:** 16/06/2021**Responsible Officer:** Development Manager**1. POLICY STATEMENT**

Berrigan Shire Council has an interest in ensuring the continued development of land in the Shire for higher and better use as residential, commercial, industrial or agricultural land – in line with the Council's Local Environmental Plan 2013.

The early release of subdivision certificates is one process the Council can use to encourage and support future development. However, the Council also has an obligation to ensure that the interests of the Council and the broader community are protected.

The policy will balance these two aims by setting out the principles it will follow when releasing subdivision certificates before all required works are completed.

Items requiring Council Resolution

2. PURPOSE

The purpose of the policy is to regulate the early release of subdivision certificates to encourage appropriate development of land while protecting the interests of the Council and the community.

3. SCOPE

The policy applies to all subdivisions in the Berrigan Shire local government area

4. OBJECTIVE

This Policy has been developed to assist the Council with Delivery Plan Objective 1.1.1.2

Coordinate strategic land-use planning and effective development assessment and control

5. DEFINITIONS

Compliance Certificate	A certificate referred to in section 109C (1) (a) of the <i>Environmental Planning and Assessment Act 1979</i>
Development Consent	Consent under Part 4 of the <i>Environmental Planning and Assessment Act 1979</i> to carry out development
Occupation Certificate	A certificate referred to in section 109C (1) (c) of the <i>Environmental Planning and Assessment Act 1979</i>
Subdivision Certificate	A certificate referred to in section 109C (1) (d) of the <i>Environmental Planning and Assessment Act 1979</i>

6. POLICY IMPLEMENTATION

6.1. General principle

As a general principle, the Council will permit the release of subdivision certificates prior to all works being complete and certified provided the developer can meet the conditions set out in this policy to the satisfaction of the Development Manager

Items requiring Council Resolution

6.2. Acceptable installation of utilities

The Council will not release a subdivision certificate until the relevant authorities responsible for accepting and maintaining the following services have formally advised the Council that the work completed under contract is acceptable.

- Electricity
- Gas, and
- Telecommunications

6.3. Bank Guarantees

The Council will not accept bank guarantees as surety for incomplete works and services that are to be undertaken by private construction companies.

The Development Manager may, at his/her discretion, accept a bank guarantee in exchange for early release of subdivision certificates where the developer has entered into a contract with the Council to complete the required work

6.4. Community and Strata Tiles

6.4.1. Community Title

The Council will not release Community Title subdivision certificates until either:

- a) works associated with the subdivision of the land have been undertaken in accordance with the requirements of this policy, or
- b) for works associated with medium density dwelling developments incorporating the subdivision of land which has been approved under the provisions of clause 4.1c of Berrigan Local Environmental Plan 2013 the following applies:
 - (i) completion of the first stage of an approved "Staged Development" and issue of building Occupation Certificate, or
 - (ii) completion of
 1. at least one dwelling unit and issue of an Occupation Certificate, and
 2. construction of subsequent dwelling units included in the development consent to at least Framework Compliance Certificate stage, and

Items requiring Council Resolution

3. the works associated with the subdivision approval have been completed

6.4.2. Strata Title

The Council will not release Strata Title subdivision certificates until completion of all required construction work associated with the subdivision and after issue of building Occupation Certificates.

6.5. Exceptions to policy

The General Manager is authorised to permit exceptions to this policy where he/she considers that strict compliance with the policy would frustrate the purpose of the policy set out above.

7. RELATED POLICIES

7.1. Legislation

- *Local Government Act 1993*
- *Environmental Planning and Assessment Act 1979*

7.2. Policies and other Council plans

- **Berrigan Local Environmental Plan 2013**
- **Commercial Credit Policy**
- **User Fees and Charges Policy**
- **Berrigan Development Control Plan 2014**

REPORT:

To encourage and support future development, Berrigan Shire Council has the option of allowing the early release of subdivision certificates. To mitigate the risks involved with allowing an early release, the Council has adopted a policy to regulate this option.

The existing policy was adopted in 2006 and is overdue for review. In discussions with Council staff, their view was that the current policy works well and is balanced between encouraging development and protecting the Council and community. As such, the proposed policy above has been written to retain unaltered the existing policy settings and merely brings the policy in line with the Council's standard policy template.

The Council should note that the policy does allow the General Manager significant discretion to permit exceptions to the policy where strict compliance would frustrate the aims of the policy.

Items requiring Council Resolution

While allowing the early release of subdivision certificates is sometimes useful, the Council is under no obligation to allow it if it does not wish to do so.

NO - H U L O S E R

Items requiring Council Resolution

5.11 PRE-EMPLOYMENT MEDICAL POLICY**AUTHOR:** Director Corporate Services**STRATEGIC OUTCOME:** Good government**STRATEGIC OBJECTIVE:** 2.1 Berrigan Shire 2022 objective and strategies inform Council planning and community led projects**FILE NO:** 22.123.1**RECOMMENDATION:** - that the Council:

- revoke its Policy for Pre-Employment Medical; and
- adopt the Policy for Pre-Employment Medical set out below.

08 PRE-EMPLOYMENT MEDICAL POLICY**File Reference No:** 22.123.1**Strategic Outcome:** Good government**Date of Adoption:** 21/06/2017**Date for Review:** 16/06/2021**Responsible Officer:** Director Corporate Services**1. POLICY STATEMENT**

As a responsible employer, Council has obligations and a duty of care under s344 of the *Local Government Act 1993* and the *Workplace Health and Safety Act 2010* with respect to employees' safety and risk.

Considering these obligations, Berrigan Shire Council expects all prospective employees to undertake a pre-employment medical examination which includes drug and alcohol screening.

2. PURPOSE

A proper medical examination will afford Council accurate guidance as to the physical capability of a prospective employee to perform the job for which they have applied

Items requiring Council Resolution

3. SCOPE

This policy applies to:

- Prospective employees
- Council Human Resources staff
- Council management

4. OBJECTIVE

This Policy has been developed to assist the Council with Delivery Plan Action 2.1.3.5

Manage human resource and workforce development activities through the implementation of the Berrigan Shire's Workforce Development Plan 2017 – 2021

5. POLICY IMPLEMENTATION

5.1. Scope

All persons selected for temporary, casual and permanent appointment to Council's service will be required to undergo a pre-employment medical examination and drug and alcohol screen to determine fitness to perform nominated duties.

These examinations will be conducted by a medical practitioner approved by Council and will be at Council's expense on the understanding that the examination forms a further part of the selection process.

In each instance pre-employment medical examinations are to be carried out appropriate to the employment duties.

A permanent employee will not be permitted to start work with Berrigan Shire Council until the results of the pre-employment medical examination and drug and alcohol screen have been returned to and considered by the Council.

5.2. Assessment

The Council will provide the approved doctor with a position description and a breakdown of tasks including a comprehensive ergonomic analysis.

The doctor is to assess an applicant's capacity to undertake the tasks required in the relevant position. The applicant is also required to accurately represent his/her physical condition and special requirements.

Information from the employer and applicant will then ensure that the doctor is fully informed and in a position to assess an applicant's suitability for tasks within a given job. The range of assessments for the

Items requiring Council Resolution

doctor to apply will not necessarily preclude applicants from employment if they are not totally fit medically.

The doctor is to report and assess within a range of classifications and to comment on special requirements.

The classifications are:

1. Suitable for employment.
2. Suitable for employment but with a minor problem which will not affect his/her work but which may need protection, or modification of task or workplace
3. Suitable for employment in position proposed, may be unsuitable for other positions.
4. Not suitable for employment in the position or a substantial workers compensation insurance risk. Would place themselves or others at risk if required to perform tasks stated.

The Council will provide a standard form for the assessing doctor to complete and return to the Council.

5.3. Drug and Alcohol Screening

Berrigan Shire Council is a drug and alcohol free workplace. Possession, consumption or being under the influence of alcohol or drugs will not be permitted during working hours, including overtime and during call-outs. As part of its commitment to ensure a safe environment for other employees and the general public, Council will insist that new employees pass the pre-employment drug and alcohol screen.

All persons selected for permanent appointment to Council's service will be required to undergo a pre-employment drug and alcohol screen in line with AS 4308:2008 Procedures for specimen collection and the detection and quantitation of drugs of abuse in urine.

The screen will form part of the pre-employment medical.

The results of the screen may lead to the Council not proceeding with an offer of employment.

5.4. Outcomes

Previous injuries or current impairments do not jeopardise prospective employment unless:

1. an applicant would be unable to do the job
2. if doing the job constitutes a substantial risk to themselves or others
3. if the special requirements of the applicant cannot reasonably or practicably be met.

Items requiring Council Resolution

Medical information collected by the Council under this policy will only be used for the purposes of assessing suitability for employment as per the *Privacy and Personal Information Act 1998* and *Health Records and Information Privacy Act 2002*

6. RELATED POLICIES OR STRATEGIES

6.1. Legislation

- *Local Government Act 1993*
- *Workplace Health and Safety Act 2010*
- *Anti-Discrimination Act 1977*
- *Privacy and Personal Information Act 1998*
- *Health Records and Information Privacy Act 2002*
- *Local Government (State) Award 2010*
- *AS/NZS 4308:2008 Procedures for specimen collection and the detection and quantitation of drugs of abuse in urine*

6.2. Council policies and guidelines

- **Berrigan Shire Council Code of Conduct**
- **Berrigan Shire Council Privacy Management Plan**
- **Drug and Alcohol Free Workplace Policy**
- **Equal Employment Opportunity, Workplace Bullying and Harassment Policy**

REPORT:

The Council's policy for Pre-Employment Medical is due for review.

The policy provides sets out the principles the Council will follow when assessing prospective employees for suitability for employment on medical grounds.

The changes to the existing policy are largely cosmetic and procedural. The policy does now specifically make it clear that no permanent employee will be permitted to start the duties with the Council until the results of the pre-employment medical examination and drug screen have been returned to and assessed by the Council.

The Council may adopt, amend or reject this proposed policy as it chooses.

Items requiring Council Resolution

5.12 REVENUE POLICY

AUTHOR: Director Corporate Services

STRATEGIC OUTCOME: Good government

STRATEGIC OBJECTIVE: 2.2 Ensure effective governance by Council of Council operations and reporting

FILE NO: 25.138.1

RECOMMENDATION: - that the Council:

- revoke its Policy for Revenue; and
- adopt the Policy for Revenue set out below.

REVENUE POLICY

File Reference No: 25.138.1

Strategic Outcome: Good government

Date of Adoption: 21/06/2017

Date for Review: 20/06/2018

Responsible Officer: Director Corporate Services

1. POLICY STATEMENT

Clause 201 of the *Local Government (General) Regulation 2005* requires Berrigan Shire Council to prepare an annual statement of the Council's revenue policy. This is included in the Council's Operational Plan.

This policy provides information regarding the levying of Council's rates, its fees and charges and other major income sources.

Rates and charges provide Council with a major source of revenue to meet the cost of providing services to residents of the Shire.

2. PURPOSE

The rates and charges described below are levied to provide the net funding requirements of the programs and initiatives identified in the Annual Operational Plan 2017/18.

Items requiring Council Resolution

3. SCOPE

This policy covers the setting and levying of all Council rates, charges and fees for the financial year ending 30 June 2018

4. OBJECTIVE

This policy is developed to assist the Council with the following Delivery Program 2017 – 20121 Objectives:

- 2.1.3 Council operations and financial management support ethical, transparent and accountable corporate governance.

5. POLICY IMPLEMENTATION

Total revenue raised from the levying of land rates continues to be capped by the State Government with the Independent Pricing & Regulatory Tribunal (IPART) having developed a Local Government Cost Index (LGCI) for use in setting the maximum allowable increase in general income for local government. IPART has set the maximum allowable increase as 1.5% for the 2017/18 rating year.

Ordinary Rates

Section 494 of the *Local Government Act 1993* (LGA), requires Council to make and levy an Ordinary rate for each year on all rateable land in the local government area.

Ordinary rates are applied to properties based on applying an ad Valorem Rate-in-\$ to the independent land valuations provided by the NSW Department of Lands (Valuer General's Office).

Council is required to use the latest valuations received up until 30 June of the previous year for rating purposes in the current financial year. Shire-wide general revaluations are undertaken every 3 years.

Valuations, with a base date 01/07/2016, will be used for rating purposes for 01/07/2017 – 30/06/2018.

In accordance with Section 493 and 514 of the *Local Government Act 1993*, all parcels of rateable land within Councils boundaries have been declared to be within one of the following categories:

- Farmland
- Residential
- Business
- Mining

Items requiring Council Resolution

The determination of the sub category for each parcel of rateable land is in accordance with the definitions set out in Sections 515, 516, 517, 518, 518A, 519 and 529 of the *Local Government Act 1993*.

The applicable subcategories for each category are as follows:

Farmland subcategories

- Farmland – Berrigan
- Farmland – Barooga
- Farmland – Finley
- Farmland – Tocumwal
- Farmland – Gravel Pits

Residential subcategories

- Residential
- Residential – Barooga
- Residential – Berrigan
- Residential – Finley
- Residential – Tocumwal
- Residential Rural – Barooga
- Residential Rural – Berrigan
- Residential Rural – Finley
- Residential Rural – Tocumwal
- Residential – River Land Barooga
- Residential – River Land Tocumwal

Business subcategories

- Business Ordinary – Barooga
- Business Ordinary – Berrigan
- Business Ordinary – Finley
- Business Ordinary – Tocumwal
- Business Industrial – Berrigan
- Business Industrial – Finley
- Business Industrial – Tocumwal
- Business Industrial – Barooga
- Business Hospitality – Berrigan
- Business Hospitality – Barooga
- Business Hospitality – Finley
- Business Hospitality – Tocumwal
- Business Rural – Barooga
- Business Rural – Berrigan
- Business Rural – Finley

Items requiring Council Resolution

- Business Rural – Tocumwal

Mining subcategories

- Mining – Berrigan
- Mining – Barooga
- Mining – Finley
- Mining – Tocumwal

Rating scenario

The ordinary rates proposed by the Council for 2017- 2018 contain a 1.5% increase, which is the increase determined by the Independent Pricing and Regulatory Tribunal (IPART).

The Ordinary rates table below illustrates the proposed rating scenario for Berrigan Shire Council. This information is based on the rating database up to June 2017.

FARMLAND

The Farmland rate is sub-categorised into regional districts, based on the urban/town locations. The farmland rate will be one ad Valorem rate shire wide.

Farmland – Ad Valorem Rate = \$0.0059126 cents in the dollar, based on the 2016 unimproved capital value of the property.

Estimated Total Yield of Farmland = \$1,840,268.00

(Farmland = 36.66% of the total yield)

RESIDENTIAL – BAROOGA

The Residential rate for Barooga is worked out on the basis that the average valued property in Barooga will pay the same as the average valued property in each town in the Shire. The Residential category may apply if the land is zoned or designated for residential purposes

Residential Barooga – Ad Valorem Rate = \$0.010539 cents in the dollar, based on the 2016 unimproved capital value of the property.

Estimated Total Yield of Residential Barooga = \$544,471.00

BUSINESS – BAROOGA

Land is categorised as Business-Barooga if it is of a business, commercial or industrial nature. Business- Barooga has four sub-categories: Business Industry, Business Ordinary, Business Hospitality and Business Rural Each category has the same ad Valorem as Residential Barooga.

Items requiring Council Resolution

Business Barooga – Ad Valorem = 0.010539 cents in the dollar, based on the

2016 unimproved capital value of the property

Estimated total yield of Business Barooga = \$92,578.00

(Residential and Business Barooga = 12.69% of the total yield)

RESIDENTIAL – BERRIGAN

The Residential rate for Berrigan is worked out on the basis that the average valued property in Berrigan will pay the same as the average valued property in each town in the Shire. The Residential category may apply if the land is zoned or designated for residential purposes.

Residential Berrigan – Ad Valorem Rate = 0.034155 cents in the dollar, based on the 2016 unimproved capital value of the property.

Estimated total yield of Residential Berrigan = \$330465.00

BUSINESS – BERRIGAN

Land is categorised as Business-Berrigan if it is of a business, commercial or industrial nature. Business- Berrigan has four sub-categories: Business Industry, Business Ordinary, Business Hospitality and Business Rural. Each category has the same ad Valorem as Residential Berrigan.

Business Berrigan – Ad Valorem = 0.034155 cents in the dollar, based on the 2016 unimproved capital value of the property.

Estimated total yield of Business Berrigan = \$73,365.00

(Residential and Business Berrigan = 8.04% of the total yield)

RESIDENTIAL – FINLEY

The Residential rate for Finley is worked out on the basis that the average valued property in Finley will pay the same as the average valued property in each town in the Shire. The Residential category may apply if the land is zoned or designated for residential purposes.

Residential Finley – Ad Valorem = \$0.026709 cents in the dollar, based on the 2016 unimproved capital value of the property.

Estimated total yield of Residential Finley = \$667,658.00

BUSINESS - FINLEY

Land is categorised as Business - Finley if it is of a business, commercial or industrial nature. Business - Finley has four sub-categories: Business

Items requiring Council Resolution

Industry, Business Ordinary, Business Hospitality and Business Rural. Each category has the same ad Valorem as Residential Finley.

Business Finley – Ad Valorem + \$0.026709 cents in the dollar, based on the 2016 unimproved capital value of the property.

Estimated total yield of Business Finley = \$158002.00

(Residential and Business Finley = 16.45% of the total yield)

RESIDENTIAL – TOCUMWAL

The Residential rate for Tocumwal is worked out on the basis that the average valued property in Tocumwal will pay the same as the average valued property in all towns shire wide. The Residential category may apply if the land is zoned or designated for residential purposes

Residential Tocumwal – Ad Valorem Rate = 0.011202 cents in the dollar, based on the unimproved capital value of the property.

Estimated total yield of Residential Tocumwal = \$740,550.00

Land is categorised as Business -Tocumwal if it is of a business, commercial or industrial nature. Business-Tocumwal has four sub-categories: Business Industry, Business Ordinary, Business Hospitality and Business Rural. Each category has the same ad Valorem as Residential Tocumwal

Business Tocumwal – Ad Valorem = 0.011202 cents in the dollar, based on the 2016 unimproved capital value of the property.

Estimated total yield of Business Tocumwal = \$181,372.00

(Residential and Business Tocumwal = 18.36% of the total yield)

RESIDENTIAL RURAL

The Residential Rural rate is a Residential sub-category and is based on the criteria provided by the LGA, it usually located outside a town category. The ad Valorem is less to reflect less use of town facilities. The ad Valorem is the same across the shire.

Residential Rural – Ad Valorem = \$0.006284 cents in the dollar, based on the 2016 unimproved capital value of the property.

Total yield of Residential Rural = \$337,116.00

(Residential Rural = 6.72% of the total yield)

RESIDENTIAL – Riverland Tocumwal & Riverland Barooga

Items requiring Council Resolution

This is a sub-category of Residential and is for semi-rural properties that may not strictly fit Residential or Rural Residential criteria and will generally be less than the adjoining towns' rate.

Residential – Ad Valorem = \$0.0090012 cents in the dollar, based on the 2016 unimproved capital value of the property.

Total Yield of Residential = \$54,483.00

(Residential = 1.09% of the total yield)

Annual service and utility charges

Domestic Waste and Non-Domestic Waste Management Services

Berrigan Shire Council intends to make the following charges for levying in 2017- 2018 to meet the reasonable costs associated with the collection, disposal and recycling of waste in accordance with Sections 496, 501 and 504 of the *Local Government Act 1993*.

Berrigan Shire Council will levy annual charges for the following services:

2017/18 WASTE MANAGEMENT SERVICE CHARGES

SERVICE PROVIDED	2017/18 FEE (\$ PER ANNUM	ESTIMATED REVENUE 2017/18	% VARIATION
Domestic Waste Collected 1 x Weekly Pick up of 120 litre small garbage bin (Green) 1 x Fortnightly pick up 240 litre recycling bin (Blue)	\$279.00	\$903,681	2.5%
Additional Service Collected 1 x Weekly Pick up of 120 litre small garbage bin (Green)	\$187.00	\$1,683	2.5%
Uncollected (vacant charge) Charged on vacant land within the collection zone – no service is provided.	\$55.00	\$15,015	2.5%
Business / Non Residential Garbage Charge 1 x Weekly pick up of 240 litre big bin. (Green)	\$261.00	\$62,640	2.5%

Items requiring Council Resolution

Garbage and Recycling Charge 1 x Weekly pick up of 240 litre big garbage bin. (Green) 1 x Fortnightly pick up of 240 litre recycling bin. (Blue)	\$384.00	\$9,984	2.5%
Recycling Collected 1 x Fortnightly pick up of 240 litre recycling bin. (Blue)	\$124.00	\$3,472	2.5%

Sewer Charges

In accordance with the provisions of Section 535, 501 and 552 of the *Local Government Act 1993*, a special rate or charge relating to sewerage will be levied on all rateable land confined within the area shown on each of the Town Sewer Supply areas except:

- i) Land which is more than 75 metres from a sewer of the Council and is not connected to the sewer;
- ii) Land from which sewerage could not be discharged into any sewer of the Council.

Berrigan Shire Sewerage will operate as one entity and each rateable property in Barooga, Berrigan, Finley and Tocumwal will have the same sewerage supply charge applied as specified in Council's Annual Fees and Charges. In addition, a standard pedestal charge per cistern/water closet in excess of two will be raised on all rateable properties with more than 2 cisterns/water closets.

In special circumstances, an on-site low pressure sewer maintenance charge will apply to those properties connected to Council's sewer supply via a low-pressure sewer pump. The Council will maintain the pump in perpetuity subject to the owner of the property entering into an agreement for maintenance and paying the annual low- pressure charge.

These charges are specified in Council's Annual Fees and Charges.

- For non-rateable properties

A standard pedestal charge per cistern/water closet will be raised on all non-rateable properties connected to the sewerage supply.

- For rateable properties outside village boundaries

Rateable properties outside the existing village boundaries, and connected to the town sewer supply, will be charged the normal town sewer supply charges, including pedestal charges if applicable.

Items requiring Council Resolution

The Table below sets out the intended sewer charges for 2017/18:

2017/18 SEWER CHARGES

SERVICE PROVIDED	FEE PER ANNUM	ESTIMATED REVENUE	% VARIATION
Sewer Supply Charge Charged to all rateable land utilising the town sewer system or zoned residential and within 75m of Councils sewer system.	\$526.00	\$1,819,960	2.5%
Pedestal Charge Any property with more than 2 (two) cisterns/water closets will be charged a pedestal charge per excess cistern/water closet. A pedestal charge per cistern/water closet will be raised on all non-rateable properties connected to the sewer supply	\$112.00	\$163,632	2.5%
On-Site Low Pressure Maintenance Charge Applied to properties connected to Councils' sewerage supply via a low-pressure pump. Council maintains the pump in perpetuity subject to the owner paying the On- site low pressure maintenance charge.	\$150.00	\$14,550	58%

Stormwater Management Services

Under the provisions of Section 535 of the *Local Government Act* 1993, Council has resolved to levy a Stormwater Management Services Charge in accordance with Sections 496A of the *Local Government Act*, and clause 125A and clause 125AA, of the *Local Government (General) Regulation* 2005

This charge will be applicable for each non-vacant urban property, or all eligible properties for which the works or service is either provided or proposed to be provided.

Items requiring Council Resolution

2017/18 STORMWATER MANAGEMENT SERVICES

<u>SERVICE PROVIDED</u>	<u>FEE PER ANNUM</u>	<u>% VARIATION</u>
Residential Premises on urban land	\$25.00	0%
Strata properties (per Strata)	\$12.50	0%
Vacant land	Exempt	0%
Commercial Premises on urban land	\$25.00	0%
Other	\$25.00	0%

Total Estimated Yield for Stormwater Management 2017/18 - \$70,025.00

Water Supply Charges

In accordance with the provisions of Section 501, 502, 535 and 552 of the Local Government Act 1993, Council has resolved that water supply charges be levied on all properties that

- i) Land that is supplied with water from a water pipe of the Council; or
- ii) Land that is situated within 225 metres of a water pipe of the Council, whether the land has a frontage or not to the public road (if any) in which the water pipe is laid, and confined within the area shown on each of the Town Water Supply areas, even though the land is not actually supplied with water from any water pipe of the Council;

subject to, water being able to be supplied to some part of the land from a standpipe at least 1 metre in height from the ground level, if such a pipe were laid and connected to Council's main.

Except for those non-rateable properties described below:

Non-rateable State Government properties of non-commercial nature without a water connection and not using the service will not be levied an annual fixed Water Access Charge.

Items requiring Council Resolution

2017/18 WATER ACCESS AND CONSUMPTION CHARGES

SERVICE PROVIDED	FEE PER ANNUM	ESTIMATED REVENUE 2017/18	% VARIATION
Water Access Charge Applied to all properties supplied with water from a water pipe of the Council or land that is situated within 225m of Councils' water supply pipes. (see Appendix A)	\$523.00	\$2,026,625	2.5%
Water Consumption Charges – Unfiltered (Barooga, Berrigan & Finley)	\$0.73 per kl (stage 4 restrictions in force) \$0.52 per kl (other restrictions in force) \$0.47 per kl (no restrictions)		0%
Water Consumption Charges – Treated (Barooga, Berrigan & Finley)	\$1.46 per kl (stage 4 restrictions in force) \$1.04 per kl (other restrictions in force) \$0.94 per kl (no restrictions)		0%
Water Consumption Charges – Treated (Tocumwal)	\$0.97 per kl (stage 4 restrictions in force) \$0.69 per kl (other restrictions in force) \$0.62 per kl (no restrictions)		0%

Water meter reads are scheduled four (4) times a year with payment generally required thirty days (30) after the issue date of the account.

Payment of Rates and Service ChargesPayment and due dates

Berrigan Shire rates and charges are payable in full or by quarterly instalments in accordance with Section 562 of the *Local Government Act* 1993.

Items requiring Council Resolution

Annual Rates and charges notices are issued in July each year and are payable in four (4) instalments on 31 August, 30 November, 28 February and 31 May.

A rate notice, or rate instalment notice, is issued at least thirty (30) days before each instalment is due.

Water Consumption Notices are issued on a quarterly basis, approximately 30 days before the charge is due for payment.

Council may agree to enter into a payment plan with a person. The amount and frequency of the payments under the agreement are required to be acceptable to Council.

Council requires all ratepayers to pay their rates in full by the due date(s). However, some ratepayers experience genuine financial hardship and may consequently request Council to consider alternative arrangements in respect of the timing of their rate payments.

Such requests must be made prior to any recovery action being undertaken, including legal action.

Concessions

i) Pensioner Concessions

Section 575 of the *Local Government Act* 1993, provides for concessions on Council rates and charges for eligible pensioners. By virtue of Section 575, an eligible pensioner may apply to Council for annual concessions on a rate or charge of:

- Up to \$250.00 on all ordinary rates and charges for domestic waste management services
- Up to \$87.50 on annual water charges.
- Up to \$87.50 on annual sewer charges

Applications for concessions must be made in writing using the appropriate form available from Council's Rates Department.

The Council believes that the concession rates set by the NSW State Government are adequate, equitable and require no additional concession to be offered by the Council

ii) Developer Concessions

Items requiring Council Resolution

Council may offer incentives in the form of rating waivers relative to annual water and sewerage charges to developers involved with multi-lot subdivisions. Applications for developer concessions are as follows:

- Written application should be submitted to the Council prior to 31st May for consideration at the June Meeting.
- Annual water and sewerage charges may be waived on the undeveloped lots of a subdivision, up to a maximum period of three (3) years, or until the lots are built upon, sold, leased or otherwise occupied (whichever is the sooner).
- No concessions under this section are given for Domestic Waste, Storm water, Pedestal or Water Consumption Charges.

Hardship Provisions

Ratepayers having difficulty meeting their commitments may be eligible for assistance and consideration.

All applications for assistance and consideration will be assessed as per the Council's adopted Hardship Policy.

Recovery of Rates and Charges, Including Water Consumption Charges

i) Reminder Notices

- If an instalment or charge is not paid within seven (7) days of the instalment or payment date, a reminder letter will be issued requesting payment within fourteen (14) days.
- If the debt remains unpaid after this time, a final notice will be issued giving seven (7) days to pay
- If an instalment or charge amount of current defaulters are less than \$300.00, initial external recovery action may be deferred until outstanding amounts reach this amount, however this will be at the discretion of the Revenue Officer.
- If the debt remains unpaid, the debt may then be referred to Councils debt recovery agency.

ii) Recovery Action – Debt Recovery Agency Procedures

- The debt recovery agency will as soon as possible, after receipt of the referral from the Council, issue a letter of demand in relation to each overdue amount advising that the Council has referred the debt to the agency for collection and that payment is required.
- Following the expiration of the payment period, the debt collection agency will issue a solicitor's letter.

Items requiring Council Resolution

- Legal proceedings will then be commenced if these notices or letters are disregarded, or if arrangements are not adhered to, with the approval of the Revenue Officer.

Note 1: Legal action procedures will be undertaken within the guidelines of the Uniform Civil Procedure Rules and the NSW *Local Government Act*. All costs associated with debt recovery will be charged to the debtor. All costs awarded by the Court will be levied as a charge against the land.

Note 2: If legal action is commenced and costs incurred prior to a debtor applying under the Hardship Provisions, then such costs will be charged to the debtor and shall not be waived, unless under the direction of the General Manager.

iii) Arrangements to Repay Rates and Charges

- A ratepayer may enter into a weekly, fortnightly or monthly arrangement to repay the rates and charges with the Council or Council's debt collection agency with a view that the arrangement will have rates and charges paid in full within twelve (12) months. Normal interest charges apply to these arrangements.
- Council's Rates Department may enter into a longer term repayment arrangement if in their opinion a ratepayer's financial circumstances warrant this. Normal interest charges apply to these arrangements.
- Ratepayers are to be advised at the time of making a repayment arrangement that if an arrangement is dishonored or changed without prior Council approval, then recovery action may commence without further notice.

iv) Interest Charges

The Council increases overdue rates by the maximum allowable in accordance with Section 566 of the *Local Government Act* 1993.

Council may write off interest charges on overdue rates, in accordance with Section 567 of the *Local Government Act* 1993. Ratepayers seeking to have interest written off under hardship provisions are to submit a written application to Council's Rates Department.

v) Sale of Property for Overdue Rates

Under Section 713 of the *Local Government Act* 1993, the Council may:

- Sell any land (including vacant land) on which any rate or charge has remained unpaid for more than five (5) years from the date on which it became payable.

Items requiring Council Resolution

- Sell any vacant land on which any rate or charge has remained unpaid for more than one year, provided that the amount of such rates and charges are more than the land valuation it received from the NSW Valuer-General.
- Any sale will be carried out by public auction in accordance with the process outlined in the Local Government Act 1993.

User Fees and Charges

Fee and Charge Setting Principles

Where legally possible, the Council intends to charge users for the provision of all goods and services that it provides.

As a general rule the Council will set its fees and charges at a rate to generate the maximum amount of revenue possible to offset the cost burden of the provision of services borne by other sources of revenue such as rates and untied grants.

Therefore, the Council will at a minimum seek to recover the full cost of service provision from its customers and clients.

This general principle will only be modified where the specific fee and charge setting principles as shown below apply.

- Efficiency:** the fees are simple and not cumbersome to administer
- Legality:** the fees are set in line with legislation and/or other legal restrictions.
- Transparency:** the nature and use of the service is understood by users
- Effectiveness:** the fees provide value for money for users
- Clarity:** users are clear about when & how fees apply
- Equity:** the fees are fairly applied across a range of users
- Ethics:** users with special service needs are not charged exorbitant fees directly in accord with the cost of higher servicing requirements

Fee setting rationales

Every fee or charge set by the Council will be based on a clear fee setting rationale. This rationale will be shown for each fee in the Fees and Charges Register.

The rationales applicable are as follows:

- (A) Statute Limited – Priced at the figure stipulated by law as applicable to this activity

Items requiring Council Resolution

(B) Cost Recovery – Priced so as to return full cost recovery for the activities provided

(C) Commercial Basis – Priced to cover the cost of the item plus a commercial mark-up

(D) Community Service Obligation – Priced at below the cost of providing this activity as provision of the activity meets a social or economic objective of the Council.

The User Fees and Charges Policy Rationale Identifier (A, B, C etc.) will appear beside the various fees and charges in the Register of Fees and Charges. Where an asterisk appears next to the Policy ID (i.e. A*, B* etc.) the Council has identified that the maximum amount charged does not cover the cost to the Council of providing the service.

Where a fee or charge is shown as “ND”, the Council has chosen not to disclose this amount – in accordance with clause 201(4) of the *Local Government (General) Regulation 2005* – as disclosure could confer a commercial advantage on a competitor of the Council.

Goods and Services Tax

The Council will use its best endeavours to determine the Goods and Services Tax (GST) status for each user fee and charge that it sets. However there may be fees and charges for which the Council is unable to confirm the GST status.

Accordingly, if a fee that is shown as being subject to GST is subsequently found not to be subject to GST, then that fee will be amended by reducing the GST to nil. Conversely, if the Council is advised that a fee which is shown as being not subject to GST becomes subject to GST, then the fee will be increased but only to the extent of the GST

Register of Fees and Charges

The complete Register of Fees and Charges is detailed in a separate document included in the 2017/18 Operational Plan.

Borrowings

The Council currently has one significant outstanding loan as summarised in the table below:

Outstanding Loans - 30 June 2016

PURPOSE	AMOUNT	TERM	RATE	ANNUAL REPAYMENTS	DUE	LENDER
LIRS Drainage	\$1,630,000	10 y	4.260%	\$200,488	Dec 2024	NAB

Items requiring Council Resolution

Loan Redemption - 2017/18 to 2020/21

FUND	2016 / 2017	2017 / 2018	2018/2019	2019/2020
General	\$200,488	\$200,488	\$200,488	\$200,488
Water	\$0	\$0	\$0	\$0
Sewer	\$0	\$0	\$0	\$0
Sub Total	\$200,488	\$200,488	\$200,488	\$200,488
TOTAL	\$200,488	\$200,488	\$200,488	\$200,488
Less LIRS subsidy	(\$34,112)	(\$30,065)	(\$25,774)	(\$21,250)
NETT COST	\$166,366	\$170,423	\$174,714	\$179,238
General	\$200,488	\$200,488	\$200,488	\$200,488

The external borrowing is a long term credit-foncier loan at a fixed interest rate repayable by monthly instalments and secured against the Council's revenues.

The Local Infrastructure Renewal Scheme (LIRS) provides the Council a 3% per annum interest rate subsidy on eligible loans. For the LIRS drainage loan, this is between \$25,000 and \$38,000 per annum over the first four years. Claims are made six monthly.

6. RELATED POLICIES OR STRATEGIES

6.1 Legislation

- *Local Government Act 1993*
- Local Government (General) Regulation 1994

6.2 Council policies and guidelines

- Berrigan Shire 2027 (Community Strategic Plan)
- Berrigan Shire Council Delivery Program 2017 – 2021
- Berrigan Shire Council Annual Operational Plan 2017 - 2018
- User Fees and Charges Policy
- Hardship Policy

Items requiring Council Resolution

APPENDIX A

1. WHERE SINGLE SUPPLY IS AVAILABLE TO PROPERTY
(Tocumwal) – Not including proposed new subdivisions outside village boundary

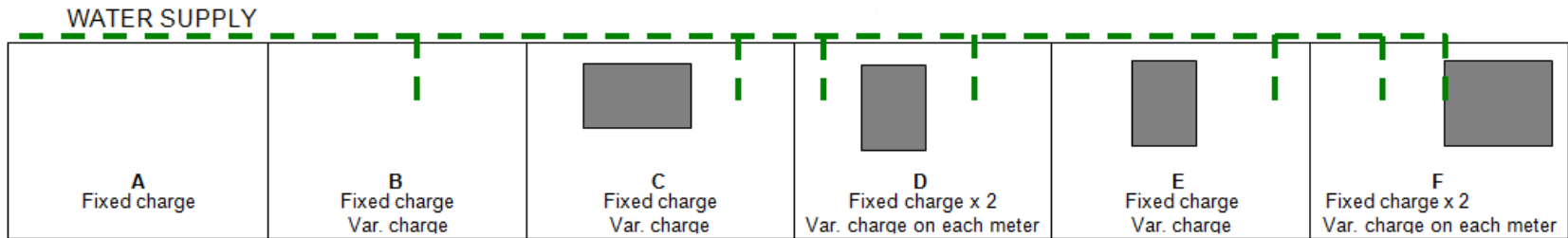

2. WHERE DUAL SUPPLY IS AVAILABLE TO PROPERTY (EXCEPT "H" – SINGLE AVAILABLE ONLY)
(Barooga, Berrigan and Finley) – Not including proposed new subdivisions outside village boundary

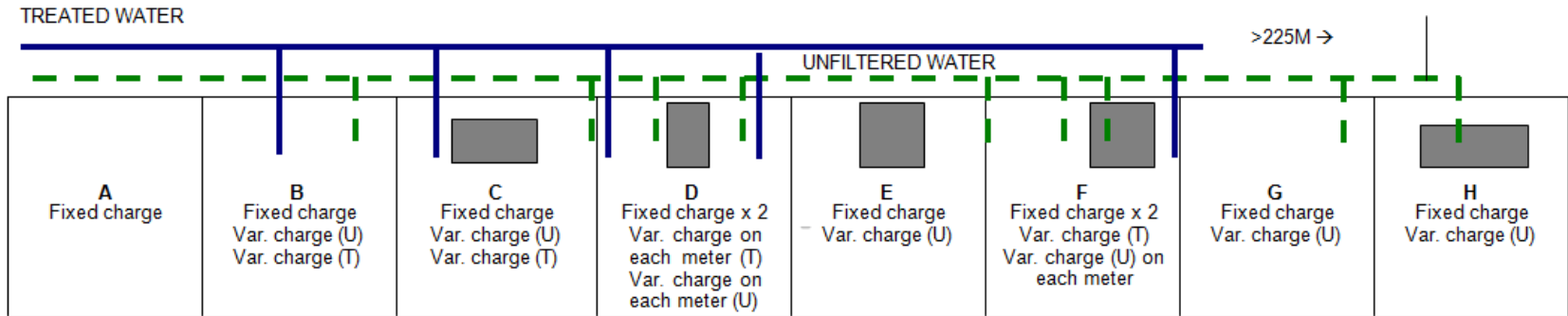

NOTE: Indicates residence or residential use with house
(T) Treated Supply
(U) Unfiltered Supply

RESOLUTION

TUC

Items requiring Council Resolution

REPORT:

Clause 201 of the *Local Government (General) Regulation 2005* requires Berrigan Shire Council to include an annual statement of the Council's revenue policy. This is included in the Council's Operational Plan.

With the Operational Plan, including the statement of the Revenue Policy, having been on public display and to be adopted at this meeting, it would be appropriate for the Council to formally adopt its Revenue Policy concurrently.

This policy provides information regarding the levying of Council's rates, its fees and charges and other major income sources. It also provided details and guidance as to how the Council will collect revenue owed.

Items requiring Council Resolution

5.13 REVOCATION OF COUNCIL POLICIES

AUTHOR: Director Corporate Services

STRATEGIC OUTCOME: Good government

STRATEGIC OBJECTIVE: 2.2 Ensure effective governance by Council of Council operations and reporting

FILE NO:

RECOMMENDATION: - that the Council revoke the following Council policies:

- 25 – Driveway Construction.
- 38 – Drainage Corridors Fire Reduction.
- 45 – Volunteering in Berrigan Shire

REPORT:

At its ordinary meeting on 21 September 2016, the Council resolved the following:

RESOLVED *Crs: Morris and Bodey that the General Manager place before the Council over the next 10 months the following for review:*

1. *Delegations to the General Manager and other organisations, Committees etc.*
2. *Code of Conduct*
3. *Code of Meeting Practice*
4. *Community Strategic Plan and supporting plans*
5. *Strategic and business plans*
6. *Organizational structure*
7. *Council Policies*
8. *Payment of Expenses and provision of Facilities Policy*

As part of that review, Council staff have identified policies that have outlived their useful life. As such, these policies could be revoked, should the Council choose to do so.

The policies are as follows:

- **25 – Driveway Construction.** This policy is largely superseded by the Council's private works procedures and its Commercial Credit Policy.
- **38 – Drainage Corridors Fire Reduction.** The policy is no longer applied by the Council.

Items requiring Council Resolution

- **45 – Volunteering in Berrigan Shire.** This policy has been superseded by the Council’s Volunteer Strategy – which itself has expired and is due for review. Other sections of the policy are covered in other Council policies or the Volunteer Committee Guide to Operations.

Copies of these policies are attached as [appendix “M”](#).

R
E
S
O
L
U
T
I
O
N

Items requiring Council Resolution

5.14 TENDER T01/17/18 ANNUAL PLANT HIRE

AUTHOR: ENGINEERING SERVICES MANAGER

STRATEGIC OUTCOME: Sustainable natural and built landscapes

STRATEGIC OBJECTIVE: 1.3 Connect and protect our communities

FILE NO: T01/17/18

RECOMMENDATION: - that the Council:

1. **accepts all compliant tenders for the 2017-18 financial year for T01/17/18 Annual Plant Hire Rates as set out below:**

**A & T GOLDMAN PTY LTD
PEARSE EARTHMOVING
ROB EX CIVIL
BELL KEARNEY EXCAVATION
BERRIGAN WATER CARTAGE
COATES HIRE
EARTH PLANT HIRE
FENHILL PTY LTD
FOXYS BACKHOE SERVICE
JOHN NOLAN PTY LTD
JUDD AND SONS PTY LTD
MILLERS CIVIL CONTRACTORS AND PLANT HIRE
MUZZASLASH AND LABOUR HIRE
NECAM PTY LTD
O'LOUGHLIN EXCAVATIONS
PASCOE'S GRADING AND EARTHMOVING
RIVERINA EARHWORKS PTY LTD
ROLLERS AUSTRALIA PTY LTD
SE AND ST LITTLE PTY LTD
RSP ENVIRONMENTAL SERVICES
SHERRIN RENTALS
STABILCO P/L
STEPHEN HAYNES PTY LTD
THE MINING PTY LTD
TOX FREE**

2. **sign and seal the contract documents.**
3. **appoint the Director of Technical Services as the Contract Superintendent and the Engineering Services Manager as the Superintendents' Representative.**

**R
E
S
O
L
U
T
I
O
N**

Items requiring Council Resolution

REPORT:

This tender is for T01/17/18, Annual Plant Hire Rates. The Council wishes to compile a list of available specific items of plant for hire to supplement its own plant fleet. The list is to enable the Council to select suitable plant on a 'Best Value' basis to support the delivery of works and services to the community as required.

The contract is a schedule of rates contract.

Tenders closed at 2:00pm Wednesday 14th of June, 2017. At the time of closing a total of twenty-five submissions were received.

Submissions were received from the following organizations:

1. A & T GOLDMAN PTY LTD
2. PEARSE EARTHMOVING
3. ROB EX CIVIL
4. BELL KEARNEY EXCAVATION
5. BERRIGAN WATER CARTAGE
6. COATES HIRE
7. EARTH PLANT HIRE
8. FENHILL PTY LTD
9. FOXYS BACKHOE SERVICE
10. JOHN NOLAN PTY LTD
11. JUDD AND SONS PTY LTD
12. MILLERS CIVIL CONTRACTORS AND PLANT HIRE
13. MUZZASLASH AND LABOUR HIRE
14. NECAM PTY LTD
15. O'LOUGHLIN EXCAVATIONS
16. PASCOE'S GRADING AND EARTHMOVING
17. RIVERINA EARHWORKS PTY LTD
18. ROLLERS AUSTRALIA PTY LTD
19. SE AND ST LITTLE PTY LTD
20. RSP ENVIRONMENTAL SERVICES
21. SHERRIN RENTALS
22. STABILCO P/L
23. STEPHEN HAYNES PTY LTD
24. THE MINING PTY LTD
25. TOX FREE

Consideration of the Tenders

All tenders were considered by the Tender Evaluation Committee consisting of Matthew Clarke and Fred Exton.

All tenders submitted were deemed compliant with the specification.

Supervisor

The superintendent of the contract will be the Director of Technical Services and the superintendent's representative will be the Engineering Services Manager.

Items requiring Council Resolution

5.15 TENDER T02/17/18 SUPPLY OF QUARRY PRODUCTS**AUTHOR: ENGINEERING SERVICES MANAGER****STRATEGIC OUTCOME: Sustainable natural and built landscapes****STRATEGIC OBJECTIVE: 1.3 Connect and protect our communities****FILE NO: T02/17/18****RECOMMENDATION: - that the Council**

1. **accepts all compliant tenders for the 2017-18 financial year for T02/17/18 Supply of Quarry Products as et out below:**

**A & T GOLDMAN PTY LTD
LAWRENCE BROTHERS
EB MAWSONS & SONT'S PTY LTD
JUDD & SONS PTY LTD**

2. **sign and seal the contract documents.**
3. **appoint the Director of Technical Services as the Contract Superintendent and the Engineering Services Manager as the Superintendents' Representative.**

REPORT:

This tender is for T02/17/18, Supply of Quarry Products.

The contract is a schedule of rates contract.

Tenders closed at 2:00pm Wednesday 14th of June, 2017. At the time of closing a total of four submissions were received.

Submissions were received from the following organizations:

1. **A & T GOLDMAN PTY LTD**
2. **LAWRENCE BROTHERS**
3. **EB MAWSONS & SONT'S PTY LTD**
4. **JUDD & SONS PTY LTD**

Consideration of the Tenders

All tenders were considered by the Tender Evaluation Committee consisting of Matthew Clarke and Fred Exton.

All tenders submitted were deemed compliant with the specification.

Items requiring Council Resolution

Supervisor

The superintendent of the contract will be the Director of Technical Services and the superintendent's representative will be the Engineering Services Manager.

R
E
S
O
L
U
T
I
O
N

Items requiring Council Resolution

5.16 TENDER T03/17/18 SUPPLY OF ELECTRICAL SERVICES**AUTHOR: ENGINEERING SERVICES MANAGER****STRATEGIC OUTCOME: Sustainable natural and built landscapes****STRATEGIC OBJECTIVE: 1.3 Connect and protect our communities****FILE NO: T03/17/18****RECOMMENDATION: - that the Council**

1. **accepts all compliant tenders for the 2017-18 financial year for T03/17/18 Supply of Electrical Services as set out below:**

SYMMETRIX**PBS POWER SERVICES PTY LTD****MURRAY VALLY LOCATING & ELECTRICAL****MARCUS MCMILLIAN ELECTRICAL****KERFOOT ELECTRICS****COBRAM ELECTRICAL & DATA**

2. **sign and seal the contract documents.**
3. **appoint the Director of Technical Services as the Contract Superintendent and the Engineering Services Manager as the Superintendents' Representative.**

REPORT:

This tender is for T03/17/18, Supply of Electrical Services.

The contract is a schedule of rates contract.

Tenders closed at 2:00 pm Wednesday 14th of June, 2017. At the time of closing a total of six submissions were received.

Submissions were received from the following organizations:

1. SYMMETRIX
2. PBS POWER SERVICES PTY LTD
3. MURRAY VALLY LOCATING & ELECTRICAL
4. MARCUS MCMILLIAN ELECTRICAL
5. KERFOOT ELECTRICS
6. COBRAM ELECTRICAL & DATA

Consideration of the Tenders

All tenders were considered by the Tender Evaluation Committee consisting of Matthew Clarke and Fred Exton.

All tenders submitted were deemed compliant with the specification.

**R
E
S
O
L
U
T
I
O
N**

Items requiring Council Resolution

Supervisor

The superintendent of the contract will be the Director of Technical Services and the superintendent's representative will be the Engineering Services Manager

R
E
S
O
L
U
T
I
O
N

Items for Noting

RECOMMENDATION – that Items for Noting numbered 6.1 to 6.3 inclusive be received and noted.

6.1 LIONS PARK, TOCUMWAL

AUTHOR: Director Corporate Services

STRATEGIC OUTCOME: Supported and engaged communities

STRATEGIC OBJECTIVE: 3.2 Support community engagement through life-long learning, culture and recreation

FILE NO: 15.128.29

REPORT:

In 2013 the Council was successful with a funding application under the Community Building Partnership (CBP) program for improvements to Lions Park in Tocumwal, adjacent to Hennessey Street. The grant was for \$15,000 to be matched dollar-for-dollar by the Council.

The proposed improvements included an irrigation system, with a pump and tank, and a shelter and seating.

At the time, the Council wished to revise the funding agreement to remove the requirement to install a shelter and instead plant trees. However this request was somehow lost in the system despite numerous attempts to have a revised funding agreement sent through.

In May 2017, the Council was sent a letter by Family and Community Services NSW (FACS) – the body administering CBP – re-offering the initial funding offer with some conditions:

- No variations to the initial funding agreement would be permitted.
- The Council must return a signed funding agreement by 31 May 2017.
- The works must be complete by 30 September 2017.
- The grant must be acquitted by 31 October 2017.

The Council has accepted these terms and returned the funding agreement. The Council will need to recommit its \$15,000 towards this contribution for the project to proceed.

NOTING

Items for Noting

6.2 FINANCIAL ASSISTANCE GRANT

AUTHOR: Director Corporate Services

STRATEGIC OUTCOME: Good government

STRATEGIC OBJECTIVE: 2.2 Ensure effective governance by Council of Council operations and reporting

FILE NO: 15.128.5

REPORT:

In May, the Federal Government announced that it would pay 50% of the 2017/18 Financial Assistance Grants (FAG) to local government in advance – i.e. in the 2016/17 financial year. For Berrigan Shire Council this is approximately \$2.2m. A Local Government Grants Commission circular is attached as [appendix “N”](#).

The Federal Government has paid FAG in advance previously – between 2010-11 and 2013-14.

Ostensibly, the Federal Government has painted this as a way to get cash to local governments to allow them to spend on local infrastructure quickly. In reality, it is a way for the Federal Government to adjust its outgoings and manipulate its headline cash deficit figure.

It also does nothing for local government as FAG is already fully committed in local government budgets each year. The Federal Minister for Local Government, Senator Fiona Nash, made this exact point before the federal budget: “Paying councils early does not give them more money”.

For smaller, rural councils such as Berrigan Shire, the early payment also has a significant impact on the Council’s financial statements. Under Australian Accounting Standards, income from grants must be brought to account in the year in which it is received. This will mean the Council’s revenue and operating surplus will be inflated by \$2.1m in 2016/17. The flip side is that when the “in advance” payments are stopped, the Council’s revenue and operating surplus will take a corresponding hit.

While the actual cash available to the Council will not change, the early payment will grossly distort the Council’s financial statements and its financial Key Performance Indicators for at least two years.

Items for Noting

6.3 DEVELOPMENT DETERMINATIONS FOR MONTH OF MAY 2017

AUTHOR: Executive Support Officer

STRATEGIC OUTCOME: Good government

STRATEGIC OBJECTIVE: 2.2 Ensure effective governance by Council of Council operations and reporting

FILE NO:

REPORT:

APPLICATIONS DETERMINED FOR MAY

Application	Description	Property Location	Applicant	Owner	Status	Value	Days Taken		
82/17/DA/D1	Transportable Dwelling	3 BUSHLANDS ROAD, TOCUMWAL NSW 2714 (Lot542//DP1107605)	Mr Trevor Turner	MR TJ TURNER	Reviewed 19-04-2017	\$ 120000.00	Active 30	Total 74	
99/17/DA/DM	Single Mooring	BAROOGA NSW 3644 (Lot A//DP420480)	Mr David Murphy	SPUD NOMINEES PTY LTD	Approved 11-04-2017	\$ 0.00	Active 28	Total 28	
108/17/DA/D3	Workshop / Shed	76-78 DENLIQUIN ROAD, TOCUMWAL NSW 2714 (Lot104//DP1141944)	A & A Vanderhoek	MR A VANDERHOEK AND MRS AJ VANDERHOEK	Approved 19-04-2017	\$ 115000.00	Active 21	Total 21	
110/17/DA/D1	New Dwelling	21 MOORE STREET, TOCUMWAL NSW 2714 (Lot8/3//DP6464)	Mrs Sigrid & Mr Arthur Potter	MS S POTTER & MR A G POTTER	Approved 12-04-2017	\$ 300945.00	Active 8	Total 10	
111/17/DA/D5	2 Bay Extension to Existing Shed & Removal of Old Shed & Carport	55 DENISON STREET, FINLEY NSW 2713 (Lot12//DP567704)	Ms Maureen Bevan	MS MA BEVAN	Approved 19-04-2017	\$ 3300.00	Active 14	Total 14	
113/17/DA/D5	Residential Storage Shed	BUSHLANDS ROAD, TOCUMWAL NSW 2714 (Lot81//DP1138438)	Ms Margaret Dingley	BUSHLANDS RESORT PTY LIMITED	Approved 12-04-2017	\$ 2500.00	Active 5	Total 5	
114/17/DA/D5	Residential Storage Shed	BUSHLANDS ROAD, TOCUMWAL NSW 2714 (Lot70//DP1138438)	Mr Darren Sanders	BUSHLANDS RESORT PTY LIMITED	Approved 12-04-2017	\$ 2000.00	Active 5	Total 5	
62/17/CD/M1	BV Dwelling & Attached Garage	55-57 SNELL ROAD, BAROOGA NSW 3644 (Lot2//DP1133714)	Stuart Ratcliffe & Caroline Burnside	MR S J RATCLIFFE & MS C M BURNSIDE	Approved 24-04-2017	\$ 251266.00	Active 9	Total 9	
63/17/CD/M1	BV Dwelling & Attached Garage	3051 MULWALA-BAROOGA ROAD, BAROOGA NSW 3644 (Lot92//DP1128142)	Mr Craig Lawson	MR C R LAWSON	Approved 24-04-2017	\$ 276711.00	Active 9	Total 9	
64/17/CD/M6	Verandah	39 BARINYA STREET, BAROOGA NSW 3644 (Lot3//DP42493)	Mr Kevin Sidebottom	MR B A OLDHAM AND MRS E J OLDHAM	Approved 26-04-2017	\$ 14850.00	Active 4	Total 4	

NOTING

Items for Noting

116/17/DA/D3	Transportable Office Building	12 HARLEY COURT, FINLEY NSW 2713 (Lot23//DP713898)	GB & TJ May	MR GB MAY & MR TJ MAY	Approved 28-04-2017	\$ 22000.00	Active 6	Total 6
65/17/CD/M1	BV Dwelling & Attached Garage	4 GEORGE STREET, TOCUMWAL NSW 2714 (Lot89//DP1096540)	James & Maryanne Piner	MR J W PINER AND MRS M A PINER	Approved 24-04-2017	\$ 258503.00	Active 2	Total 2
66/17/CD/M4	Residential Storage Shed	STREET, BERRIGAN NSW 2712 (Lot10/4//DP758097)	Mrs Lorraine Buckle	MRS B L BUCKLE	Approved 27-04-2017	\$ 3500.00	Active 1	Total 1
67/17/CD/M4	Residential Storage Shed	ROAD, BAROOGA NSW 3644 (Lot50//DP1045702)	Mrs Danielle Beveridge	MR J M BEVERIDGE	Approved 27-04-2017	\$ 8990.00	Active 1	Total 1

APPLICATIONS PENDING DETERMINATION AS AT 9/06/2017

Application No.	Date Lodged	Description	Property Location
128/17/DA/D2	25-05-2017	Pilates & Myotherapy Studio & Demolition of Existing Shed	249 MURRAY STREET, FINLEY NSW 2713 (Lot 13//DP260805)
130/17DA/D2	29-05-2017	2x Additional Retail Outlets / Shops	57-59 VERMONT STREET, BAROOGA NSW 3644 (Lot 2//DP205743)
133/17DA/D1	07-06-2017	Transportable Dwelling	448 YARRAWONGA ROAD, BERRIGAN NSW 2712 (Lot 27//DP752291)
134/17/DA/D5	08-06-2017	Residential Storage Shed	32-36 MORRIS STREET, TOCUMWAL NSW 2714 (Lot B//DP370062)

TOTAL APPLICATIONS DETERMINED / ISSUED (including modifications)

	This Month (May)	Year to Date	This Month's Value	Year to Date Value
<i>Development Applications (DA)</i>	11	134	\$593,000	\$15,063,731
<i>Construction Certificates (CC)</i>	3	82	\$494,000	\$13,580,953
<i>Complying Development Certificates (CDC)</i>	6	75	\$680,260	\$5,950,245
<i>Local Activity (s.68)</i>	7	93	0	0

OTHER CERTIFICATES ISSUED FOR MAY

	149(2) Planning Certificate		149(5) Certificate		735A Certificate Outstanding Notices or Orders under LG Act 1993		121zp Certificate Outstanding Notices or Orders under EP&A Act 1979		149(D) Building Certificate		Swimming Pool Certificate	
	May	Year Total	May	Year Total	May	Year Total	May	Year Total	May	Year Total	May	Year Total
BAROOGA	10	98	1	3	0	2	0	1	0	2	5	23
BERRIGAN	0	50	0	5	0	14	0	4	0	0	0	3
FINLEY	10	118	1	16	1	9	1	3	0	0	0	2
TOCUMWAL	12	109	0	3	1	8	0	1	0	1	3	18
TOTAL	32	375	2	27	2	33	1	9	0	3	8	46

Items for Noting

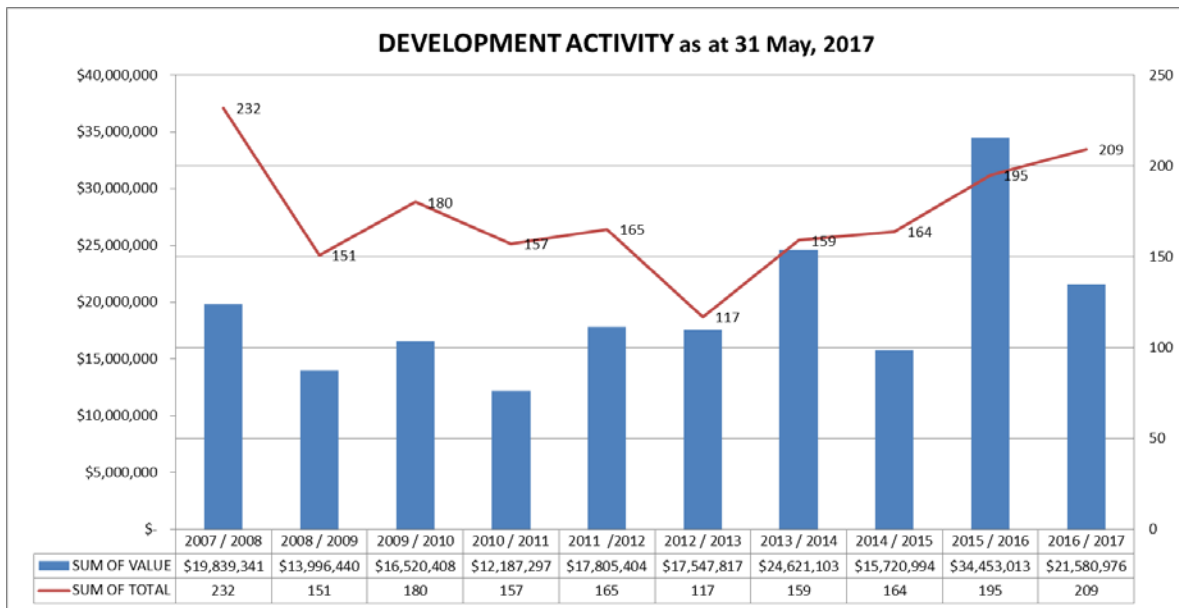
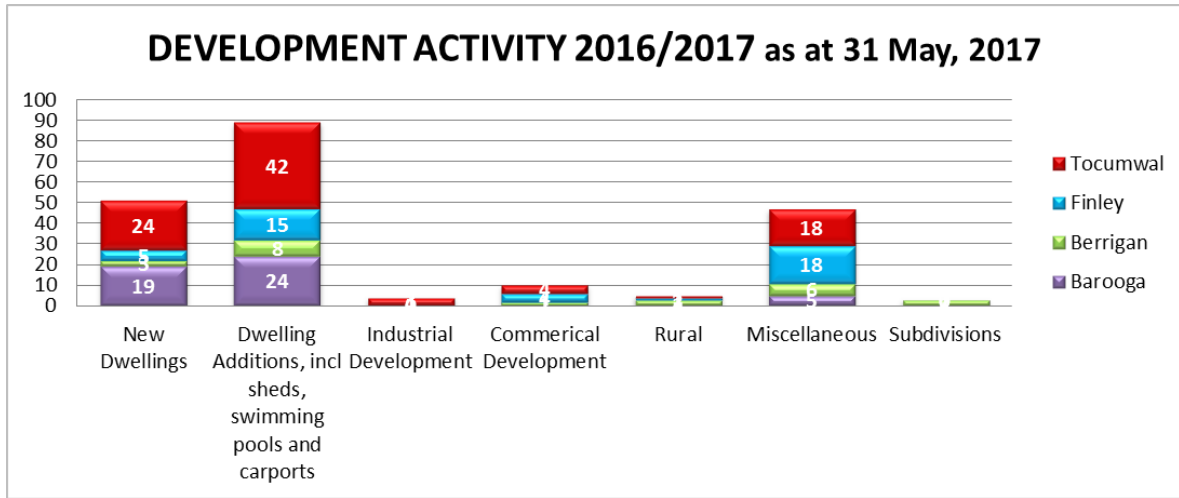

NOTING

Items requiring Council Resolution

7. CLOSED COUNCIL

In accordance with the *Local Government Act 1993* and the Local Government (General) Regulation 2005, in the opinion of the General Manager, the following business is of a kind as referred to in section 10A(2) of the Act, and should be dealt with in a part of the meeting closed to the media and public.

Set out below is section 10A(2) of the *Local Government Act 1993* in relation to matters which can be dealt with in the closed part of a meeting.

The matters and information are the following:

- (a) personnel matters concerning particular individuals (other than councillors)
- (b) the personal hardship of any resident or ratepayer
- (c) information that would, if disclosed, confer a commercial advantage on a person with whom the council is conducting (or proposes to conduct) business
- (d) commercial information of a confidential nature that would, if disclosed:
 - (i) prejudice the commercial position of the person who supplied it, or
 - (ii) confer a commercial advantage on a competitor of the council, or
 - (iii) reveal a trade secret
- (e) information that would, if disclosed, prejudice the maintenance of law
- (f) matters affecting the security of the council, councillors, council staff or council property
- (g) advice concerning litigation, or advice that would otherwise be privileged from production in legal proceedings on the grounds of legal professional privilege
- (h) information concerning the nature and location of a place or an item of Aboriginal significance on community land.

7.1 BERRIGAN BANKING PROPOSAL – DISCUSSION PAPER

This item is classified CONFIDENTIAL under section 10A(d)(i) of the *Local Government Act 1993*, which permits the meeting to be closed to the public for business relating to the following:

Items requiring Council Resolution

- (d) commercial information of a confidential nature that would, if disclosed:
 - (i) prejudice the commercial position of the person who supplied it, or

It is not in the public interest to reveal the commercial information.

RECOMMENDATION - that the Council move into a closed session to consider the following business together with any reports tabled at the meeting.

And further that pursuant to section 10A(1)-(3) of the *Local Government Act 1993*, the media and public be excluded from the meeting on the basis that the business to be considered is classified confidential under the provisions of section 10A(2) as outlined above and that the correspondence and reports relevant to the subject business be withheld from access to the media and public as required by section 11(2) of the *Local Government Act 1993*.

7.1 BERRIGAN BANKING PROPOSAL – DISCUSSION PAPER

Council closed its meeting at The public and media left the Chamber.

**R
E
S
O
L
U
T
I
O
N**

Confidential Items requiring Council Resolution

C
O
N
F
I
D
E
N
T
I
A
L

Items requiring Council Resolution

Open Council resumed at

RESOLUTIONS FROM THE CLOSED COUNCIL MEETING

The following resolutions of the Council while the meeting was closed to the public were read to the meeting by the Mayor:

RESOLUTION

Committee meeting reports

8.1 MINUTES OF THE TECHNICAL SERVICES COMMITTEE MEETING

RECOMMENDATION – that recommendations numbered 1 inclusive of the Technical Services Committee Meeting held on 7th June, 2017 be adopted.

5. HALF COST SCHEME 06/16/17 NANGUNIA STREET, BAROOGA

AUTHOR: Executive Engineer

STRATEGIC OUTCOME: Sustainable natural and built landscapes

STRATEGIC OBJECTIVE: 1.3 Connect and protect our communities

FILE NO: HCS 06/16/17

RECOMMENDATION NO. 1 – that:

1. In accordance with Council's policy: Contributory Footpath And Kerb And Gutter Schemes Policy pursuant to clauses 217,218 & 219 of the Roads Act 1993, proceed with the construction of footpath along Nangunia Street, Barooga (Takari Street to end of residential subdivision west side) and make a charge on abutting property owners in accordance with the Schedule for Scheme 06/16/17 as set out below.

SCHEDULE: SCHEME NO. 06/16/17

NANGUNIA STREET, BAROOGA FOOTPATH CONSTRUCTION (TAKARI STREET TO END OF RESIDENTIAL SUBDIVISION WEST SIDE)

Property	Owner's Percentage	Frontage (m)	Total Cost \$	Owner's Cost Excl GST \$	GST \$	Total Owner's Cost Incl. GST \$	Council Cost \$
6 BEATRICE COURT, BAROOGA 3644, (LOT 34 DP1102913)	25%	5.32	\$574.56	\$143.64	\$14.36	\$158.00	\$430.92
47-51 TAKARI STREET, BAROOGA 3644, (LOT 1 DP1174446)	25%	19.95	\$2,154.60	\$538.65	\$53.87	\$592.52	\$1,615.95

Committee meeting reports

8 RUSSELL COURT, BAROOGA 3644, (LOT 17 DP1102913)	25%	34.49	\$3,724.92	\$931.23	\$93.12	\$1,024.35	\$2,793.69
8 BEATRICE COURT, BAROOGA 3644, (LOT 32 DP1102913)	25%	40	\$4,320.00	\$1,080.00	\$108.00	\$1,188.00	\$3,240.00
7 BEATRICE COURT, BAROOGA 3644, (LOT 33 DP1102913)	25%	31.07	\$3,355.56	\$838.89	\$83.89	\$922.78	\$2,516.67
10 RUSSELL COURT, BAROOGA 3644, (LOT 15 DP1102913)	25%	5.11	\$551.88	\$137.97	\$13.80	\$151.77	\$413.91
9 RUSSELL COURT, BAROOGA 3644, (LOT 16 DP1102913)	25%	34.39	\$3,714.12	\$928.53	\$92.85	\$1,021.38	\$2,785.59
7 RUSSELL COURT, BAROOGA 3644, (LOT 18 DP1102913)	25%	5.51	\$595.08	\$148.77	\$14.88	\$163.65	\$446.31
Berrigan Shire Council Road Reserve	0%	88.00	\$9,504.00	\$0.00	\$0.00	\$0.00	\$9,504.00
Total		263.84	\$28,494.72	\$4,747.68	\$474.77	\$5,222.45	\$23,747.04

Estimated full unit rate is \$90.00 excluding GST per square metre, inclusive of survey, design, construction and supervision.

Committee meeting reports

8.2 MINUTES OF THE RISK MANAGEMENT COMMITTEE MEETING

RECOMMENDATION – that recommendations numbered 1 to 3 inclusive of the Risk Management Committee Meeting held on 7th June, 2017 be adopted.

4. PLAYGROUND MANAGEMENT

AUTHOR: Enterprise Risk Manager

STRATEGIC OUTCOME: Good government

STRATEGIC OBJECTIVE: 2.2 Ensure effective governance by Council of Council operations and reporting

FILE NO: 27.121.2

RECOMMENDATION NO. 1 the Council

1. adopt the Playground Facility Risk Rating Register included as appendix "A"
2. revoke the existing Playground Management Policy.
3. adopt the Playground Management Policy as follows:

61. PLAYGROUND MANAGEMENT POLICY

File Reference No: 27.121.2

Strategic Outcome: Good government

Date of Adoption: 07/06/2017

Date for Review: 07/06/2021

Responsible Officer: Enterprise and Risk Manager

Committee meeting reports

1. POLICY STATEMENT

Berrigan Shire Council recognises that it has a duty of care to ensure the siting, construction and maintenance of all playgrounds under its control, is carried out in a manner that is as safe and sustainable as reasonably practicable, for the users of the playgrounds.

2. PURPOSE

The purpose of this policy is to clearly outline the methodology used when considering provision of a new playground, and measures necessary for the maintenance of existing playgrounds.

3. SCOPE

This policy applies to all playgrounds under Berrigan Shire Council's control, including the siting and installation of new playgrounds, and the workers including volunteers that are responsible for inspecting and maintaining them.

4. OBJECTIVE

This policy is designed to assist the Council to meet the following Community Strategic Plan objectives:

2.2 Ensure effective governance by Council of Council operations and reporting;

3.1 Create safe, friendly and accessible communities;

3.2 Support life-long learning, culture and recreation.

5. DEFINITIONS

Playground An area designed for children's play, including the site, natural features, built landscape and any manufactured equipment. It does not include sites and equipment intended for use in formal sport.

Playground equipment - Equipment including manufactured structures and impact absorbing surfacing.

6. POLICY IMPLEMENTATION

6.1 Determining New Playgrounds for Berrigan Shire

Decisions to install new playgrounds can be based on a number of factors including:

- Demand;
- Current use of existing playgrounds;
- Formal requests;
- Close proximity of other facilities;

Committee meeting reports

Funding of the playground will be in accordance with Council's Community Strategic Plan, Delivery Plan and Resourcing Strategy. Any opportunities to obtain funding from other sources will be pursued.

Any new proposed playgrounds will be assessed in accordance with Facility Risk Rating procedures and Council's Risk Management Policy and Framework.

6.2 Facility Risk Ratings

New and existing playgrounds are assessed and rated using the Statewide Mutual Best Practice Manual for playgrounds. The process involves:

- a) Establishing a register of all playgrounds;
- b) Determining the level of development at the playground site including natural and introduced hazards located in the vicinity of the playground equipment;
- c) Determining the number of people that use, or are likely to use the playground;
- d) Determining the frequency of use of the playground including seasonal fluctuations;
- e) Calculating a risk rating;
- f) Selecting, arranging and installing appropriate measures.

6.3 Playground Maintenance and Inspection

Council has in place a regular inspection and maintenance regime for playgrounds.

Ongoing maintenance of playgrounds will be carried out as identified through inspections, as a result of customer complaints, and as part of scheduled maintenance and recurrent expenditure programs for playgrounds.

6.4 Documentation

All records relating to the playground assessment process, and inspection and maintenance programs, will be maintained in accordance with Australian Standard requirements and as part of Council's record management system.

6.5 Monitoring and Review

The Playground Facility Risk Rating Register will be reviewed in line with policy, and where any significant change to the level of development or usage of a playground requires a reassessment of its risk and potential hazards.

Committee meeting reports

7. RELATED LEGISLATION POLICIES OR STRATEGIES

7.1 Legislation

Work Health and Safety Act 2011

Work Health and Safety Regulations 2011

AS/NZS 4486 Playgrounds and playground equipment

AS 4685.1: Playground equipment and surfacing

AS 4422: Playground surfacing

7.2 Policies and strategies

Risk Management Policy and Framework

Statewide Mutual Best Practice Manual – Playgrounds

Committee meeting reports

5. EMPLOYEE ASSISTANCE PROGRAM POLICY

AUTHOR: Enterprise Risk Manager

STRATEGIC OUTCOME: Good government

STRATEGIC OBJECTIVE: 2.2 Ensure effective governance by Council of Council operations and reporting

FILE NO: 22.112.5

RECOMMENDATION NO. 2 that Council

1. revoke the Employee Assistance Program Policy,
2. adopt the Employee Assistance Program Policy as outlined below

67 EMPLOYEE ASSISTANCE PROGRAM POLICY

File Reference No: 22.112.5

Strategic Outcome: Good government

Date of Adoption: 07/06/2017

Date for Review: 07/06/2021

Responsible Officer: Enterprise and Risk Manager

1. POLICY STATEMENT

The Berrigan Shire Council in its commitment to maintaining a safe and healthy working environment has recognised the need to provide adequate support for staff experiencing personal or work related problems by providing an Employee Assistance Program (EAP).

Council will enlist the services of an EAP provider to provide professional counselling services for its workforce.

2. PURPOSE

The purpose of this policy is to outline the provision of the EAP program and define the parameters by which the EAP program is offered.

Committee meeting reports

3. SCOPE

This policy applies to paid employees of the Berrigan Shire Council, registered volunteers of Council's S355 Committees of Management, and current elected councillors.

4. OBJECTIVE

This policy is designed to assist the Council meet the following Delivery Plan objectives:

2.2.2 Council operations support ethical, transparent and accountably corporate governance.

5. DEFINITIONS

Organisational Referral is when Council has identified a need, such as following an incident, and will arrange for EAP access.

Self-Referral is where the employee has identified a problem which they wish to discuss in a private and confidential setting without anyone in the organisation being involved in any way.

Suggested Referral is when the option of accessing the EAP is made, usually by a Supervisor or Manager, or even a work colleague.

6. POLICY IMPLEMENTATION

6.1 EAP Provider

The Council will contract a regionally located provider to manage the EAP, independent of Council. The focus will be on providing professional counselling services that meet both the employee's and Council's needs.

Information regarding the EAP Provider is available from Council's Payroll/HR Officer.

6.2 EAP Procedure

The EAP offers assistance for problems such as:

- Relationship difficulties
- Divorce and separation
- Harassment and discrimination
- Conflict
- Alcohol and drug problems
- Work related problems
- Grief and bereavement
- Financial difficulties

Committee meeting reports

- Stress and fatigue
- Emotional difficulties

The EAP is free of charge up to a maximum of three visits in one calendar year, to all Berrigan Shire Council paid employees, registered volunteers of Council's S355 Committees of Management, and current elected members of Council. Any additional visits will be at the cost of the individual.

Use of the EAP can be through self-referral, suggested referral or organisational referral. Where the referral is either suggested or organisational, use of the EAP is at the discretion of the individual and is completely voluntary.

The EAP provider will make arrangements to meet with the individual usually at a location close to their place of residence, or at the provider's premises, however on occasion an alternative venue may need to be arranged. Under these circumstances travelling will be charged according to the EAP agreement between the Council and the provider.

Where a counsellor may suggest referral to a specialist agency, any costs associated with the referral are to be met by the individual.

6.2.1 Leave requirements for paid employees

Where an employee wishes to utilise the EAP service, normal leave procedures will apply. If the referral to the EAP is a suggested or organisational referral, arrangements regarding leave or leave with pay will be made with the affected employee/s.

6.2.2 Confidentiality

A vital feature of the EAP is the confidentiality and respect for an individual's privacy. No one needs to know that an individual is utilising the services of the EAP. Should an individual confide in or advise somebody within Council that they are attending the EAP, he/she is required to observe strict confidentiality and where possible offer support.

Confidentiality also means that nobody, include the Council will receive information from the EAP provider concerning an individual situation. Conversations and any information shared with a counsellor will be confidential and will not be communicated further unless written authorisation is given.

Committee meeting reports

6.2.3 Council Contact

The EAP is facilitated by the Human Resource Officer. Information, direction, support and advice on the EAP service can be obtained by contacting the Human Resource Officer, Council's Contact Officers or by making direct contact with the EAP Provider.

Contact details of the current EAP Provider are displayed on all noticeboards.

7. RELATED LEGISLATION, POLICIES AND STRATEGIES

Additional publications to be read in conjunction with this policy include:

- *Privacy and Personal Information Protection Act 1998*
- Local Government (State) Award 2010
- Work Health and Safety Policy
- Internal Reporting Policy
- Code of Conduct
- Discrimination, Workplace Bullying and Harassment Policy
- Drug and Alcohol Free Workplace Policy
- Privacy Management Plan

Committee meeting reports

6. CLOTHING AND PROTECTIVE EQUIPMENT POLICY**AUTHOR:** Enterprise Risk Manager**STRATEGIC OUTCOME:** Good government**STRATEGIC OBJECTIVE:** 2.2 Ensure effective governance by Council of Council operations and reporting**FILE NO:** 22.112.1**RECOMMENDATION NO. 3** – that Council

1. revoke the Clothing and Protective Equipment Policy,
2. adopt the Clothing and Protective Equipment Policy as outlined below

65 CLOTHING AND PROTECTIVE EQUIPMENT POLICY

File Reference No: 22.112.1

Strategic Outcome: Good government

Date of Adoption: 07/06/2017

Date for Review: 07/06/2021

Responsible Officer: Enterprise and Risk Manager

1. POLICY STATEMENT

Council is committed to providing a safe working environment for its workers, in addition to promoting a professional image. This policy outlines the provision and use of Council uniforms, protective clothing and equipment.

2. PURPOSE

The purpose of this policy is to:

- Outline how clothing and protective equipment will be made available to Council workers;
- Advise on worker responsibility in relation to the wearing, use and maintenance of clothing and protective equipment.

Committee meeting reports

3. SCOPE

This policy applies to workers of the Berrigan Shire Council, specifically permanent and casual staff, and volunteers.

4. OBJECTIVE

This policy is designed to assist the Council meet the following Delivery Plan objectives:

2.2.1 Meet legislative requirements for Council elections, local government and integrated planning and reporting.

2.2.2 Council operations support ethical, transparent and accountably corporate governance.

5. DEFINITIONS

Operational Staff refers to personnel required to regularly work outdoors and includes water operators, sewer operators, roads construction and maintenance, parks and gardens personnel, and town maintenance.

Non-operational Staff refers to personnel who regularly work indoors and includes office staff, technical staff, and library staff.

Volunteers under this policy, specifically relates to unpaid personnel of Council's volunteer committees established under S355 of the Local Government Act 1993

Personal Protective equipment (PPE) means anything used or worn by a person to minimise risk to the person's health and safety, including air supplied respiratory equipment.

Environmental Liaison and Enforcement Officer and appropriate relief staff are those personnel responsible for enforcing Council's obligations under state legislation and local policy.

6. POLICY IMPLEMENTATION

6.1 Provision of Clothing and PPE for Operational Staff

On commencement of permanent employment, all operational staff are provided with:

- 1 x sunhat (bucket or legionnaire style)
- 1 x pair of safety work boots
- 1 x high visibility wet weather jacket
- 3 x pairs of trousers
- 3 x long sleeve shirts

Committee meeting reports

- 1 x pair of safety sunglasses
- 1 x jumper
- 1 x water bottle

The following items will be held in the Store and issued as required:

- Safety rubber boots
- Wet weather gear
- Safety helmets
- Disposable overalls
- Sunscreen
- Insect repellent

The Store Person shall order protective clothing on an as needs basis, and shall keep in stock adequate supplies of various sizes. Every effort will be made to ensure correct sizes are provided. Clothing will be stored in the Store and will be issued by the Store Person who will monitor the quantity issued.

All clothing for operational staff will include the Berrigan Shire Council logo.

6.2 Provision of Clothing for Non-operational Staff

Council employees not entitled to a uniform issue through the Store will have access to a subsidy to purchase uniforms approved by the Council from its preferred uniform supplier.

The Council will allocate an overall subsidy in its annual operating budget. This subsidy will then be shared across all eligible staff on the following basis:

- Permanent staff working more than 0.75 EFT – one full share;
- Permanent staff working less than 0.75 EFT – one half share;
- Casual staff - \$100

New staff members will be provided with their appropriate allocation amount on commencement.

Staff will be invoiced for the amount of purchases exceeding the allocation. Unspent uniform allocations will not be carried forward into the next financial year.

6.3 Provision of Clothing for environmental Liaison and Enforcement Staff

All Environmental Liaison and Enforcement staff including relief staff are issued with the same clothing and protective equipment as operational staff, however all shirts and jumpers must have the identifying “Ranger” emblem embroidered on the shoulder.

Committee meeting reports

6.4 Provision of PPE for Volunteers

Volunteers are provided with PPE relevant to their work activity. Hi-vis vests issued do not contain the Berrigan Shire Council logo.

A register of issue is maintained by the Enterprise Risk Manager.

6.5 Additional PPE

Additional PPE will be provided as needs are identified. Needs may be identified through a variety of methods including consultation, workplace inspections, worker requests, changes in legislation, etc.

6.6 Replacement of Clothing and PPE

All clothing and PPE for operational staff will be replaced on a needs basis, as determined by the Overseers. The worn or damaged items may be requested to be returned to the Store Person.

Department Managers will ensure that the level of issues to operational, non-operational and volunteers is such that the condition of the clothing (where provided) and PPE does not deteriorate to the stage where the worker's health and safety, and the image of the Council is jeopardised.

6.7 Compulsory Requirements for Clothing and PPE

All workers are required to wear high visibility jackets whenever it is a requirement of their work activity.

Other PPE (such as hard hats, ear muffs, safety glasses, etc.) shall be worn in areas designated by signage, safe work method statements, as directed to tool box meetings or through other means.

In accordance with Work Health and Safety legislation, a worker must while at work, co-operate with his or her employer or other person so far as is necessary to enable compliance with any requirement under the *Work Health and Safety Act* and *Work Health and Safety Regulations*. This requires workers to comply with any PPE and clothing requirements.

If an employee presents at work without the appropriate clothing or PPE, or whilst in an identified PPE designated area, fails to wear, removes or alters the equipment or clothing, they will be request to leave the worksite and return only when they are properly attired. Any time lost will be without pay. Further failures will result in disciplinary action in accordance with the Local Government (State) Award 2010.

Operational staff are required to wear their issued long pants and long sleeve shirts at all times.

Where non-operational staff are required to work outdoors in addition to their normal duties indoors, they are required to recognise the same personal

Committee meeting reports

protective requirements. Where long sleeved shirts have not been issued, staff are to ensure they apply sunscreen at regular intervals whilst outdoors.

6.8 Clothing and Personal Protective Equipment Maintenance

All workers are responsible for the cleanliness of their clothing and the maintenance of their PPE.

Any PPE that cannot be used for the purpose of which it is designed either due to damage or wear and tear must be immediately replaced.

6.9 Acknowledgement

It is acknowledged by Council that this policy will not be able to be applied strictly to all workers due to irregular fittings, etc. Therefore those workers will be accommodated within this policy at the General Manager's discretion.

7. RELATED LEGISLATION, POLICIES AND STRATEGIES

Additional publications to be read in conjunction with this policy include:

- *Work Health and Safety Act 2011*
- *Work Health and Safety Regulations 2011*
- Local Government (State) Award 2010
- Code of Conduct
- Work Health and Safety Policy
- Heat Street Policy
- Expenses and Facilities Guidelines for Staff

Items requiring Council Resolution

9. MAYOR'S REPORT

RECOMMENDATION – that the Mayor's Report be received.

RESOLUTION

Items requiring Council Resolution

10. DELEGATES REPORT

RESOLUTION

Items requiring Council Resolution

11. GENERAL BUSINESS

RESOLUTION